

Mandatory Housing Affordability (MHA)

URBAN DESIGN and NEIGHBORHOOD CHARACTER Study

(Draft for Public Comment)

NATURAL MARKETS



H:LA

HOUSING AFFORDABILITY
AND LIVABILITY AGENDA

Contents

Introduction	4
MHA Development Examples	8
Residential Small Lot (RSL)	10
Lowrise (LR)	18
Lowrise 1 (LR1)	
Lowrise 2 (LR2)	
Lowrise 3 (LR3)	
Neighborhood Commercial (NC)	42
Neighborhood Commercial 40 (NC-40)	
Neighborhood Commercial 55 (NC-55)	
Neighborhood Commercial 75 (NC-75)	
Neighborhood Commercial 95 (NC-95)	
Midrise (MR)	64
Other Zones	74
Highrise (HR)	
Neighborhood Commercial 125 (NC-125)	
Neighborhood Commercial 160 (NC-160)	
Industrial Commercial (IC)	
Seattle Mixed North Rainier (SM-NR)	
Seattle Mixed Dravus (SM-D)	
Overlay Zones	76

Photographs and graphics courtesy of
ZGF Architects, LLP.:

ZGF

ZIMMER GUNSUL FRASCA ARCHITECTS LLP

Introduction

Background

This report provides urban design analysis used to evaluate potential zoning changes to implement Mandatory Housing Affordability (MHA) in neighborhoods outside Downtown and South Lake Union. Under MHA, anyone developing multifamily and commercial buildings in Seattle would be required to provide for affordable housing either by building affordable homes or by paying into a fund that the City uses to support the development of affordable housing through Seattle.

Consistent with a state-approved approach for affordable housing incentive programs, MHA requirements take effect with adoption of zoning changes that increase development capacity. Zoning changes would apply in designated urban villages and in existing commercial and multifamily zones. As part of MHA implementation, we propose to expand some urban village boundaries.

This report focuses on changes in Seattle's Multifamily Residential (LR, MR, HR), Neighborhood Commercial (NC), and Commercial (C) zones. Separate [documents](#) review potential changes to implement zoning in Downtown and South Lake Union and other neighborhoods that have recently undergone area planning, such as the University District.

The zoning changes to create additional capacity vary by zone and generally include increases in the maximum height limit and the maximum floor area ratio (FAR) limit. In some zones, we propose to modify other development standards to provide additional development capacity and encourage good urban design.

Community Input

The models in this study reflect public input received since June 2016. Earlier versions of the zone change models were made available for public comment on-line, in public meetings, and in focus group meetings. Input received so far has influenced the development standards depicted in this report. Summaries of public input received and how it influenced the current draft are included.

Draft for Public Input

This is a draft to solicit further public comment. The City Council will not complete adopting zoning changes to put MHA into effect until summer 2017 or later. The MHA development examples illustrate what future buildings could look like with the MHA zoning changes.

Community Input Themes (to date):

These are overarching comments and ideas expressed by focus group and other community members during the review of example MHA zone changes:

- The proposed height and FAR increases are incremental and moderate, and are appropriate tradeoffs for affordable housing requirements.
- The proposed increases are too limited; additional affordable housing and greater zoning increases should be incorporated to help Seattle meet its affordable housing needs.
- There is no one-size-fits-all approach, and development needs to consider local factors.
- Include commercial space that is attractive to small, local businesses.
- Incorporate space for retail and other services that communities need (e.g., daycare, community spaces, shared work spaces, etc.).
- Encourage variety in building design.
- Where possible include requirements for usable open spaces, usable plazas, courtyards, mid-block cut-throughs, and similar public spaces.
- Where possible the zoning changes should ensure that residents have access to needed amenities, such as laundry facilities.
- Development in single-family zones should also be included in MHA.
- Look for ways to provide for a variety of housing types to encourage both rental and ownership housing.
- Identify fund sources for infrastructure and quality-of-life investments corresponding with anticipated population growth.
- Consider zoning changes that will encourage housing options for larger households.
- In all Seattle zones, HALA and MHA need to consider the potential displacement of existing low-cost market-rate housing as redevelopment occurs.
- Increase development capacity in small scale zones to a level that makes affordable housing performance option viable.



Comments received at the September 27, 2016 Focus Group meeting

MHA Zone Prototypes

This study compares the scale and character of development that could be allowed by existing zoning compared to development that could be built under MHA zoning changes. For each zone, a series of before and after prototypes is shown. The range of development prototypes for each zone is intended to model realistic development scenarios. The different prototypes vary by:

- site sizes and shape
- neighborhood context
- housing formats (eg. townhouses vs. apartments)
- design and massing choices

The prototypes in this report show the increment of change that can be expected for standard MHA implementation scenarios. Typical MHA capacity increases approximate a one-story increase for most zones considered. Typical zone changes will have an (M) suffix in the zone name, applied as a naming convention.

Examples of typical zoning changes include:

- C and NC zones: The zone names change to reflect the height increase. For example, an NC-65 zone becomes an NC-75 zone, reflecting a 10-foot increase in the maximum height limit.
- LR, MR, HR ZONES: The zones retain the same name, but their development standards enable additional height and/or floor area.
- Change of single family zones: Where zoning changes apply in single family areas, a typical change is to the Residential Small Lot (RSL) zone.

In certain areas, based on our community-generated [Principles for MHA Implementation](#) or community input, we propose selective zoning changes. Where selective zoning changes provide a larger increase in development capacity, larger affordable housing requirements will apply. These zones will have a (M1) or (M2) suffix indicating that higher MHA requirements apply.

Affordable Housing Quantities

Each prototype includes an estimate of how much affordable housing the development would produce through MHA. The intent of MHA is to increase production of affordable housing. Based on the amount of floor area developed in each prototype, a projection is made for both the amount of affordable homes and the amount of in-lieu payment that would be required. Housing quantities are estimates based on current assumptions about the MHA requirements, and are included to provide a sense for how such affordable housing requirements relate to the development prototypes.

Urban Design and Neighborhood Character

Seattle's growth strategy as laid out in the Seattle 2035 Comprehensive Plan is based on the urban village concept. Centered around amenities and around existing and future transit stops, urban villages will capture most of the city's expected future growth. The zoning standards recommended under Mandatory Housing Affordability build on the urban village strategy and explore opportunities to improve overall neighborhood character.

The recommended zoning includes carefully selected design standards that allow for increased development capacity without compromising the building form and scale. They offer a harmonious built landscape and as much as possible provide comfortable living spaces to building inhabitants. The prototypes explore a variety of site conditions and lot sizes and a range of unit sizes to accommodate a diversity in family and household sizes.

The location of the zoning prototypes supports livability principles. The denser Midrise (MR) and Neighborhood Commercial (NC) zones are usually closest to the urban village center services and amenities that serve more people. The Lowrise (LR) and Residential Small Lot (RSL) zones help transition to the single family areas. The proposed modification of the existing RSL zone provides greater flexibility and a variety of housing types in the scale and character of single family homes.

The next few pages discuss the development standards and the urban design elements for each zone.



The Jefferson apartments in First Hill were supported with in-lieu payments received from a development project in another location using the existing voluntary incentive zoning program.



Upper level setbacks in MHA zones will offer a less jarring built landscape to street users.



Indoor amenities offered for residents such as those in downtown mixed commercial zones will be included in the multifamily MHA zones.

MHA Development Examples



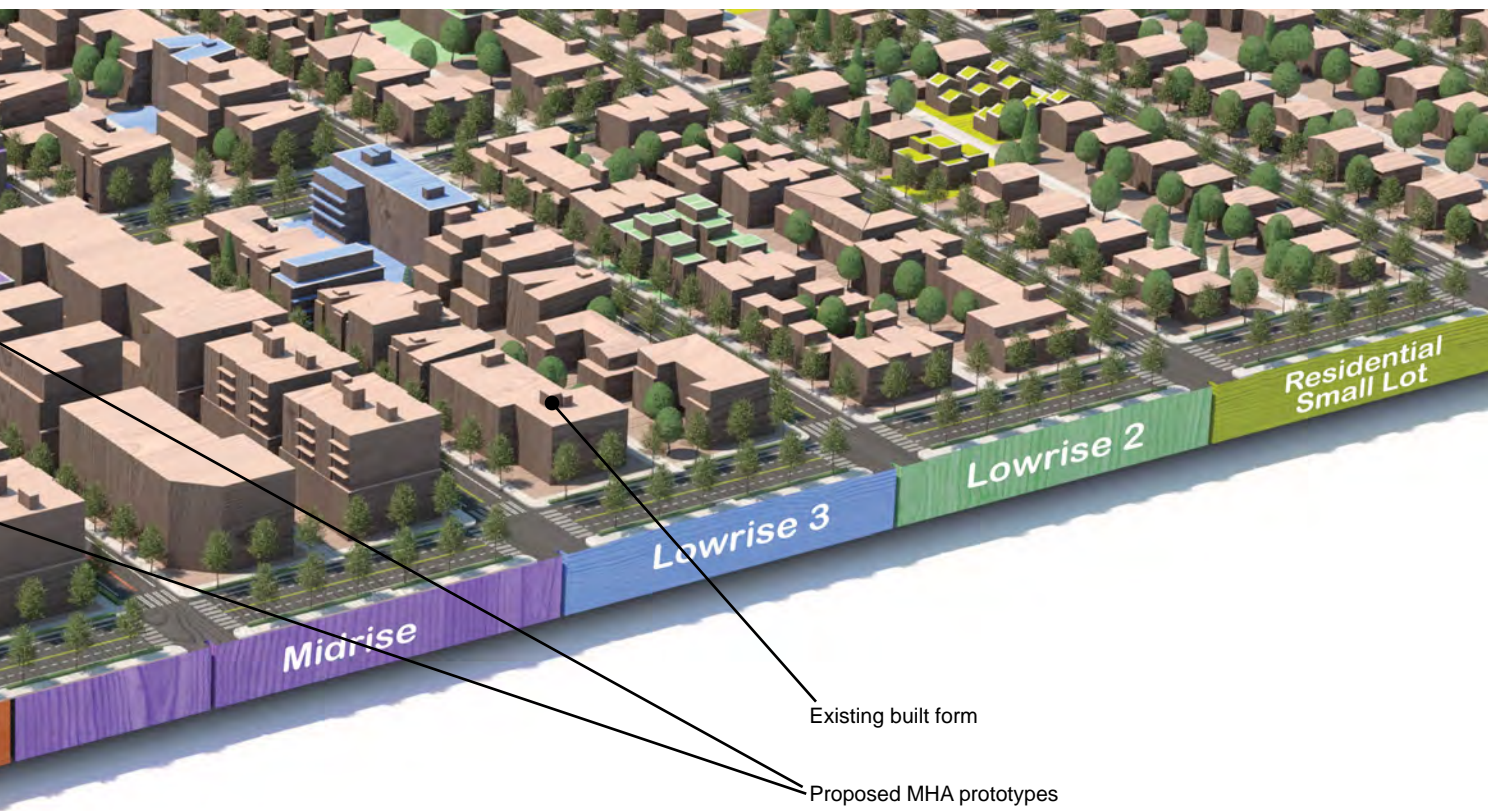

Residential Small Lot (RSL)

Community Input Themes

- A good option for areas with existing single family housing
- Ensure units are conducive to families and larger household sizes
- Explore a variety of conditions for how the housing would fit on a range of typical single family lots (i.e., 4,000, 5,000, and 6,000 sq. ft)

Development Examples

The following pages discuss four prototypes within the RSL zone: cottages, attached townhouses, stacked housing and tandem housing.



Cottages



Tandem housing



Attached townhouses



Stacked housing

Location of existing Residential Small Lot zones

Note: To date the RSL zone has been applied in only one limited area. Zoning changes to put MHA into effect would make broader use of the RSL zone, particularly in areas currently zoned Single Family.

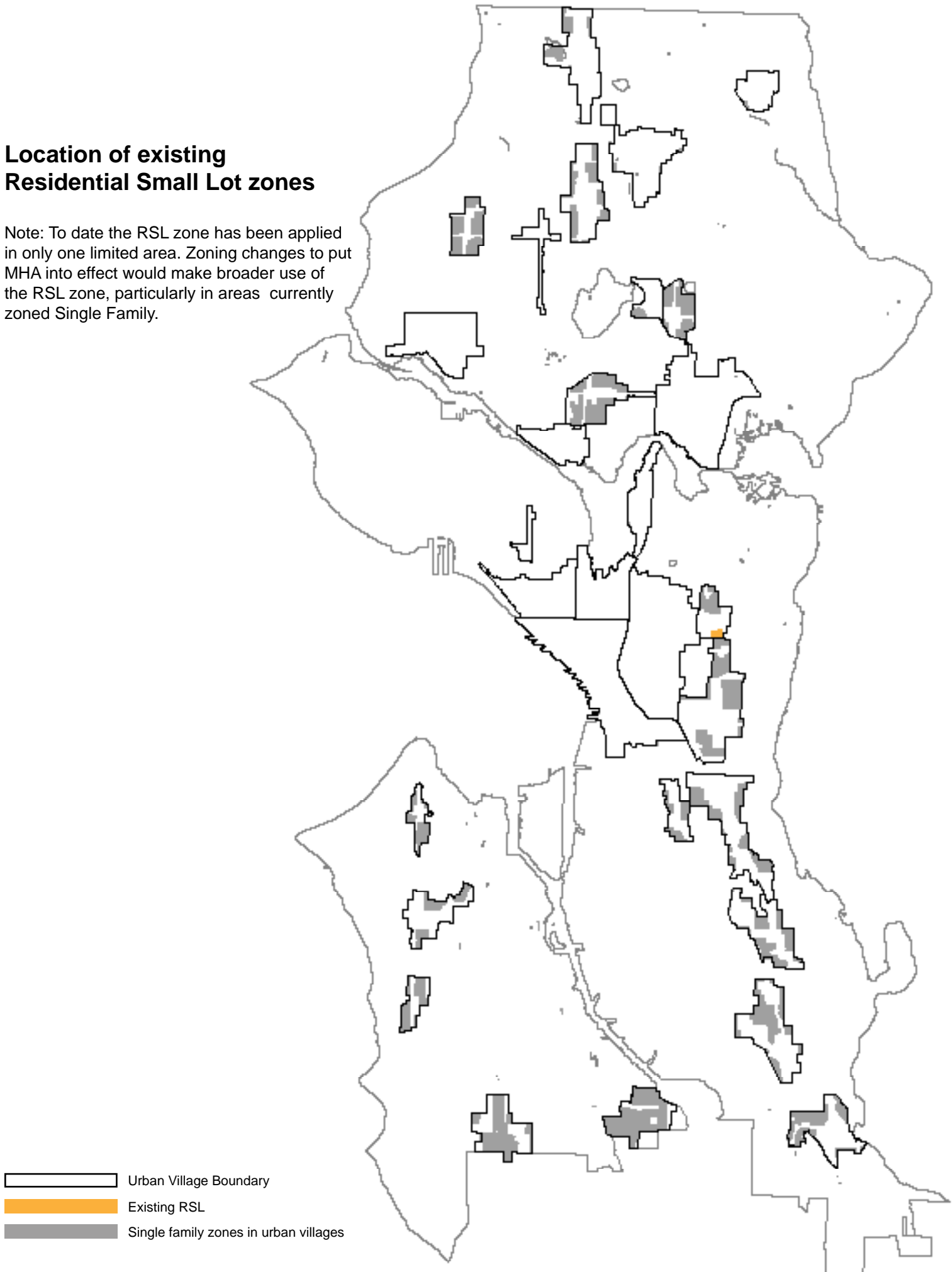

cottages

Affordable Homes

PERFORMANCE OPTION*

High MHA area (7%)	.35 = 1 unit
Medium MHA area (6%)	.30 = 1 unit
Low MHA area (5%)	.25 = 1 unit

PAYMENT OPTION

High MHA area (\$20.75/sq. ft.)	\$156,000
Med MHA area (\$13.25/sq. ft.)	\$99,000
Low MHA area (\$7/sq. ft.)	\$52,500

* If rounding down to provide affordable performance unit, developer must pay for the fraction they are rounding off as payment housing.

Proposed MHA RSL

Lot coverage	50%
Density limit	1 unit per 2000 sq. ft. of lot area
FAR maximum	0.75
Height limit	30 feet
Setbacks	
Front	10 feet
Rear	10 feet
Sides	5 feet
Parking	1 per unit; no minimum in urban villages

RSL Prototype

Lot size	10,000 sq. ft.
Lot coverage	30%
Total allowed gross area	7,500 sq. ft.
Efficiency factor	1
Total net sq. ft.	7,500 sq. ft.
Total units	5
Average net unit size	1,500 sq. ft.
Parking spaces provided	3

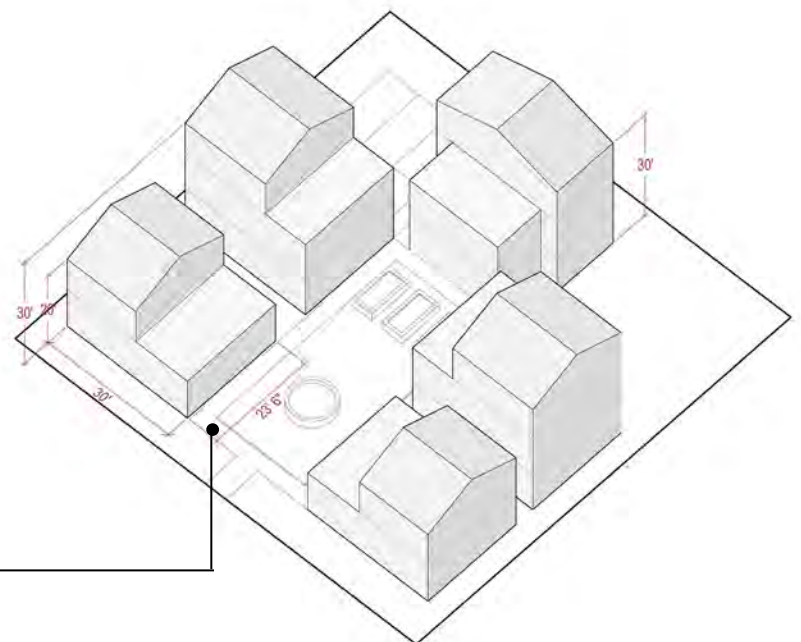

attached townhouses

Affordable Homes

PERFORMANCE OPTION*

High MHA area (7%)	.14 = 1 unit
Medium MHA area (6%)	.12 = 1 unit
Low MHA area (5%)	.10 = 1 unit

PAYMENT OPTION

High MHA area (\$20.75/sq. ft.)	\$62,000
Med MHA area (\$13.25/sq. ft.)	\$40,000
Low MHA area (\$7/sq. ft.)	\$21,000

* If rounding down to provide affordable performance unit, developer must pay for the fraction they are rounding off as payment housing.

Proposed MHA RSL

Lot coverage	50%
Density limit	1 unit per 2000 sq. ft. of lot area
FAR maximum	0.75
Height limit	30 feet
Setbacks	
Front	10 feet
Rear	10 feet
Sides	5 feet
Parking	1 per unit; no minimum in urban villages



RSL Prototype

Lot size	4,000 sq. ft.
Lot coverage	30%
Total allowed gross area	3,000 sq. ft.
Efficiency factor	1
Total net sq. ft.	3,000 sq. ft.
Total units	2
Average net unit size	1,500 sq. ft.
Parking spaces provided	2

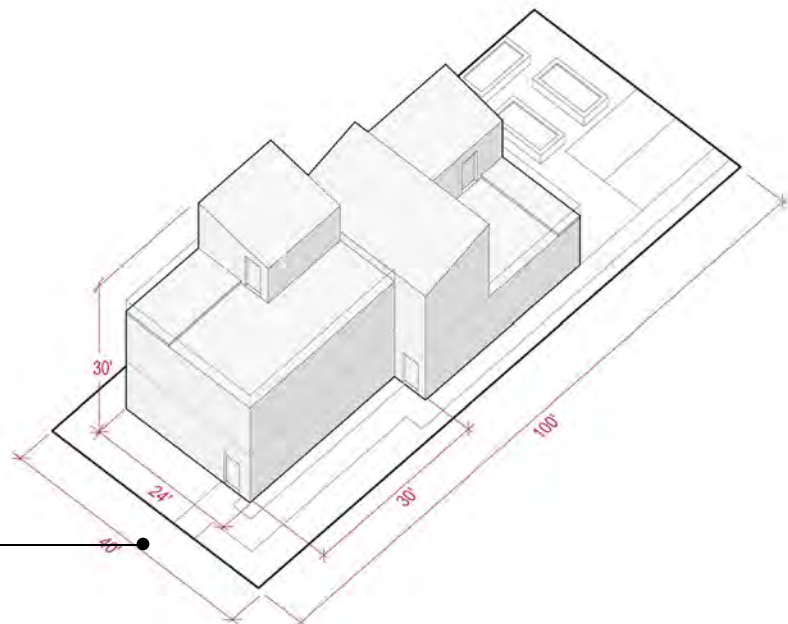

stacked housing

Affordable Homes

PERFORMANCE OPTION*

High MHA area (7%)	.21 = 1 unit
Medium MHA area (6%)	.18 = 1 unit
Low MHA area (5%)	.15 = 1 unit

PAYMENT OPTION

High MHA area (\$20.75/sq. ft.)	\$93,000
Med MHA area (\$13.25/sq. ft.)	\$60,000
Low MHA area (\$7/sq. ft.)	\$31,500

* If rounding down to provide affordable performance unit, developer must pay for the fraction they are rounding off as payment housing.

Proposed MHA RSL

Lot coverage	50%
Density limit	1 unit per 2000 sq. ft. of lot area
FAR maximum	0.75
Height limit	30 feet
Setbacks	
Front	10 feet
Rear	10 feet
Sides	5 feet
Parking	1 per unit; no minimum in urban villages

RSL Prototype

Lot size	6,000 sq. ft.
Lot coverage	25%
Total allowed gross area	4,500 sq. ft.
Efficiency factor	1
Total net sq. ft.	4,500 sq. ft.
Total units	3
Average net unit size	1,500 sq. ft.
Parking spaces provided	0

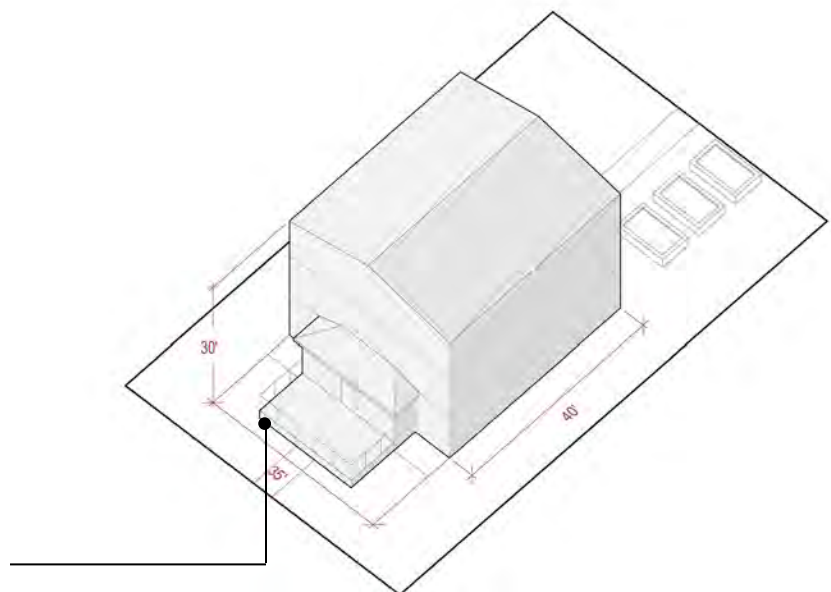

tandem housing

Affordable Homes

PERFORMANCE OPTION*

High MHA area (7%)	.07 = 1 unit
Medium MHA area (6%)	.06 = 1 unit
Low MHA area (5%)	.05 = 1 unit

PAYMENT OPTION

High MHA area (\$20.75/sq. ft.)	\$38,000
Med MHA area (\$13.25/sq. ft.)	\$25,000
Low MHA area (\$7/sq. ft.)	\$13,000

* If rounding down to provide affordable performance unit, developer must pay for the fraction they are rounding off as payment housing.

Proposed MHA RSL

Lot coverage	50%
Density limit	1 unit per 2000 sq. ft. of lot area
FAR maximum	0.75
Height limit	30 feet
Setbacks	
Front	10 feet
Rear	10 feet
Sides	5 feet
Parking	1 per unit; no minimum in urban villages

RSL Prototype

Lot size	5,000 sq. ft.
Lot coverage	45%
Total allowed gross area	3,750 sq. ft.
Efficiency factor	1
Total net sq. ft.	1,900 sq. ft. existing 1,850 sq. ft. new
Total units	1 existing, 1 new
Parking spaces provided	2

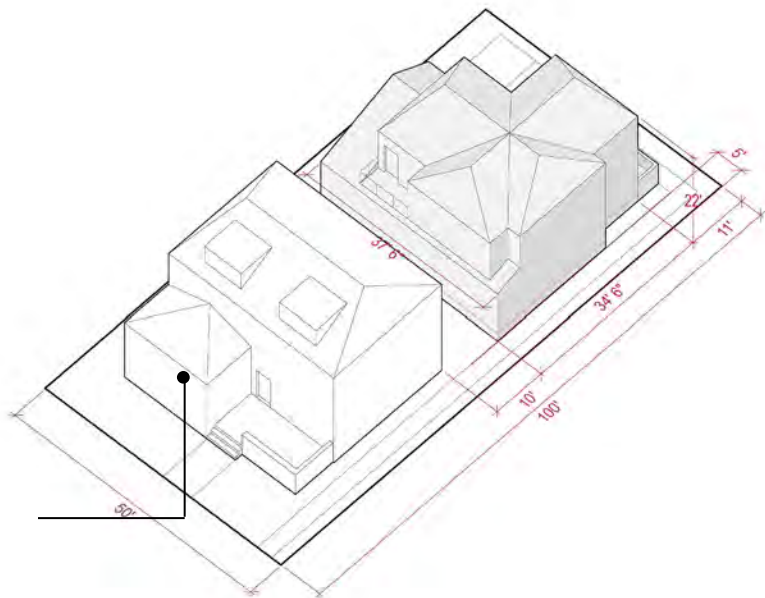

RSL Zone - Urban Design and Neighborhood Character

Livability Benefits

- Reflects traditional mixed-housing neighborhoods
- Allows a variety of housing types (e.g., cottages, small single family homes, and duplexes) at the scale of an existing single family area.
- Encourages modestly sized single family ownership homes (i.e., 1,500-2,000 sq. ft. in size)
- Provides a transition at the edges of urban villages
- Expands access for more people to live in single family neighborhoods
- Provides for on-site open spaces and yards



Provides for on-site open spaces and yards.

Proposed Development and Urban Design Standards

The following table summarizes other proposed or modified development standards intended to improve an urban design outcome and improve livability with new development in the zone.

Issue	Proposed / Modified Development Standard
Retain compatibility of scale with Single Family zones	<ul style="list-style-type: none"> • Maximum FAR limit of 0.75 • Retain a density limit of 1 unit per 2,000 sq. ft. of lot area.
Provide for a variety of infill housing types	<ul style="list-style-type: none"> • Allow for all housing types outright without a designated RSL suffix. (Currently an RSL zone must specify whether cottage, tandem, etc. is the allowed housing type.)



The Residential Small Lot zone provides a transition at the edges of urban villages and maintains the scale of single family homes.

Lowrise (LR)

Community Input Themes

- Allowing more density within the Lowrise 1 zone with the existing height limit is a good approach.
- Look for ways to ensure the housing isn't exclusively studios and small units.
- Ensure a variety of housing unit sizes particularly in the Lowrise 1 zone.
- In general, the height limit and floor area increases are incremental and a good tradeoff for the affordable housing requirement.
- Retain building design standards, including side setbacks and other design standards to manage the transition between infill buildings and context.

- The Lowrise zones are often in neighborhoods that are changing from lower density to multifamily areas.
- Require a street-facing upper-level setback where height limits are increased in the Lowrise 2 and 3 zones.
- Building entrances should face the street to enhance resident accessibility and streetscape.

Development Examples

The following pages discuss the nine prototypes within the Lowrise zones: Lowrise 1, Lowrise 2 and Lowrise 3.



Lowrise 1
large site



Lowrise 2
townhouses



Lowrise 1
small site



Lowrise 3
small site

**Location of existing
Lowrise zones**

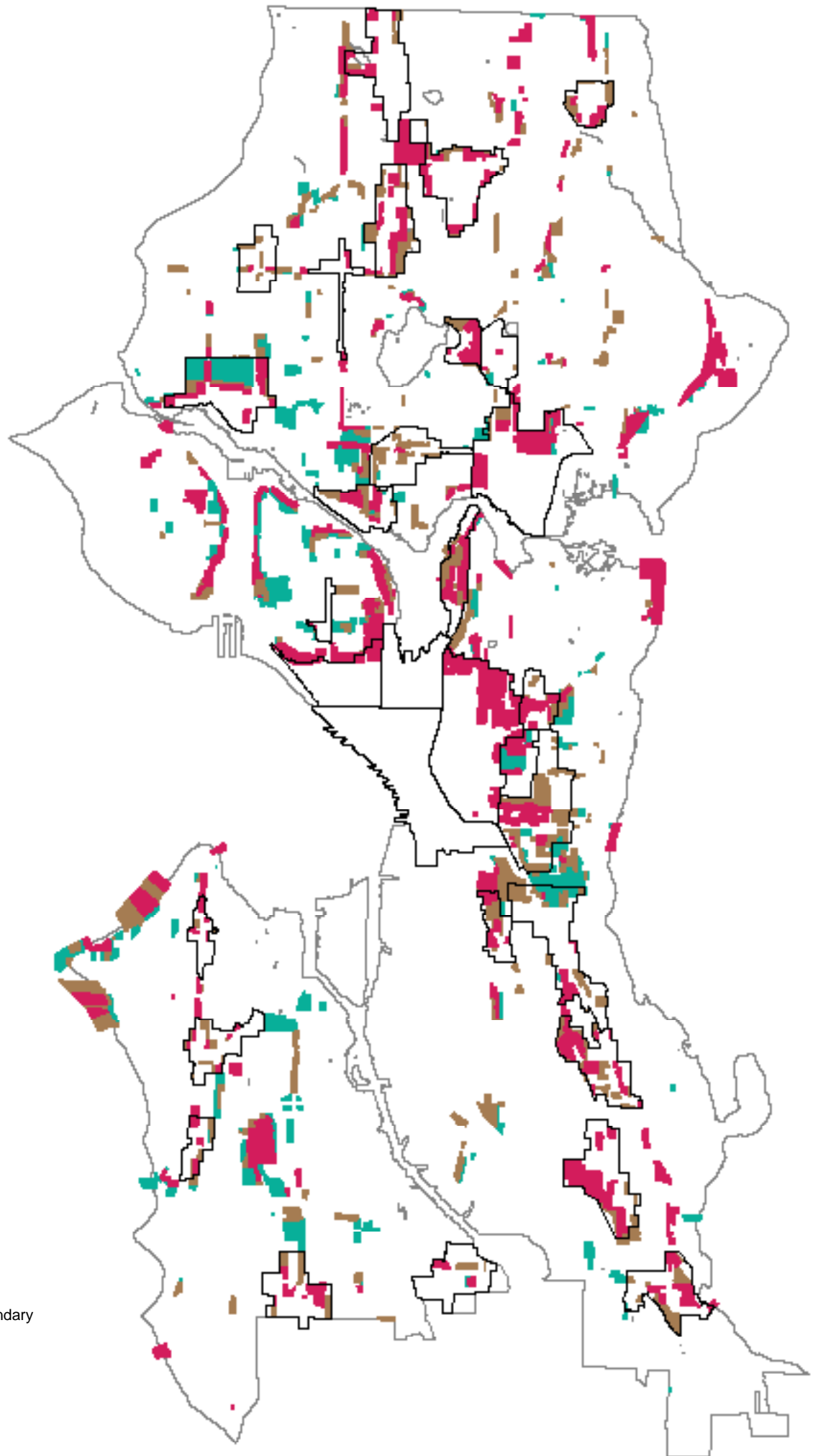

-  Urban Village Boundary
-  Existing Lowrise 1
-  Existing Lowrise 2
-  Existing Lowrise 3

LOWRISE 1

apartments | small site

Prototype Description

- A rental apartment or condominium housing product
- A commonly platted single 5,000-square-foot lot in a Lowrise zone
- No parking provided on site (urban village location)
- Considers adjacency to a mix of single family homes and small multifamily structures

Existing LR1

Density limit	1 unit per 2000 sq. ft. of lot area
FAR maximum	1.2
Height limit	30 feet
Setbacks	
Front	5 feet
Rear	10 feet with alley 15 feet without alley
Sides	< 40' bldg: 5' > 40' bldg: 7' avg, 5' min.
Parking	1 per unit; no minimum in urban villages

LR1 Prototype – Existing

Lot size	5,000 sq. ft.
Total allowed gross area	6,000 sq. ft.
Efficiency factor	0.8
Total net sq. ft.	4,800 sq. ft.
Maximum density	1 unit / 2,000 sq. ft. maximum 3 homes
Total units	2
Average net unit size	2,400 sq. ft.
Parking spaces provided	0

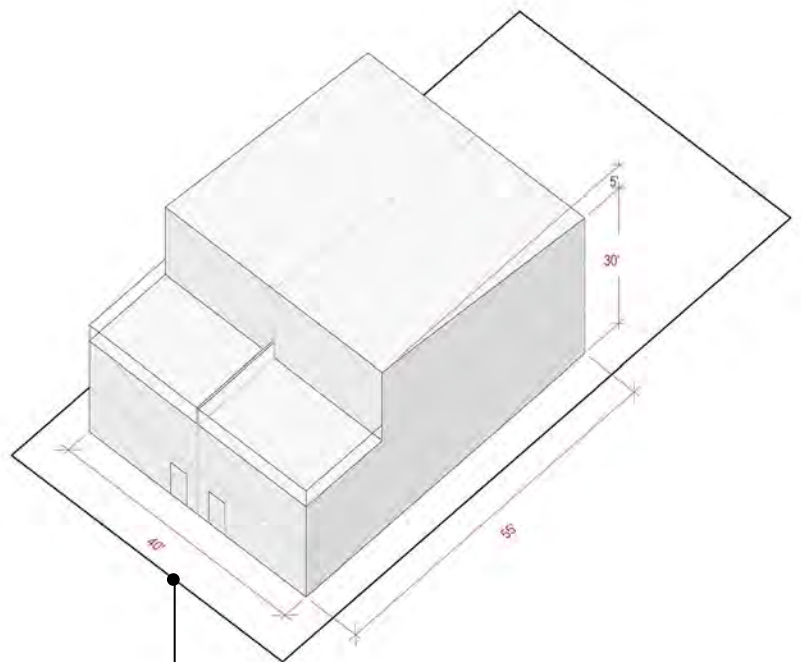

Affordable Homes

PERFORMANCE OPTION*

High MHA area (7%)	.63 = 1 unit
Medium MHA area (6%)	.54 = 1 unit
Low MHA area (5%)	.45 = 1 unit

PAYMENT OPTION

High MHA area (\$20.75/sq. ft.)	\$135,000
Medium MHA area (\$13.25/sq. ft.)	\$86,000
Low MHA area (\$7/sq. ft.)	\$45,500

* If rounding down to provide affordable performance unit, developer must pay for the fraction they are rounding off as payment housing.

Proposed MHA LR1

Density limit	Family-sized unit requirement*
FAR maximum	1.3
Height limit	30 feet
Setbacks	
Front	5 feet
Rear	10 feet with alley 15 feet without alley
Sides	< 40' bldg: 5' > 40' bldg: 7' avg, 5' min.
Parking	1 per unit; no minimum in urban villages



LR1 Prototype – Proposed

Lot size	5,000 sq. ft.
Total allowed gross area	6,500 sq. ft.
Efficiency factor	0.8
Total net sq. ft.	5,200 sq. ft.
Maximum density	Family-sized unit requirement*
Total units	9
Average net unit size	578 sq. ft.
Parking spaces provided	0

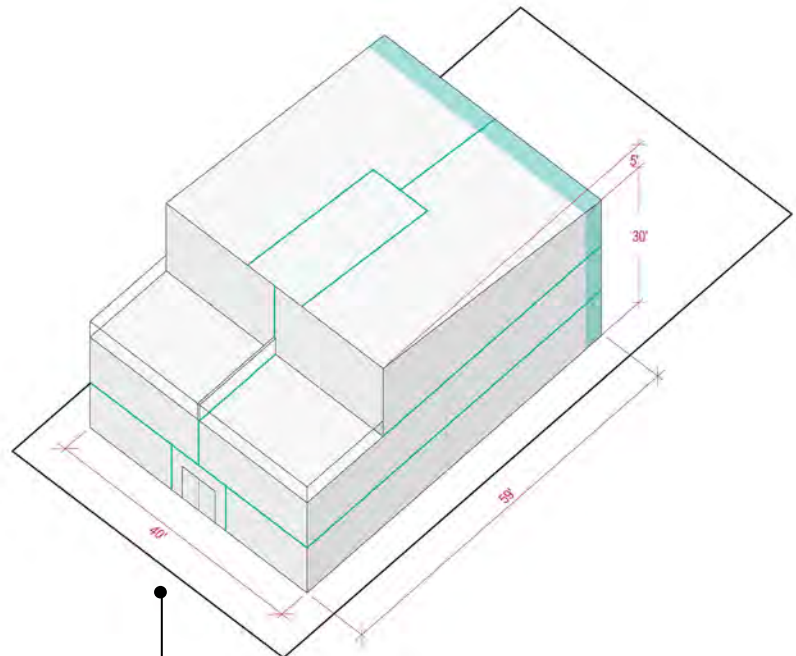

* For every 8 units, at least one 2-bedroom unit (min. 850 sq. ft.). For every 16 units, at least one 3-bedroom unit (min. 1,050 sq. ft.) or two 2-bedroom units (min. 850 sq. ft.)

LOWRISE 1

apartments | large site

Prototype Description

- A rental apartment or condominium housing product
- Two commonly platted lots in a Lowrise zone, for a total site size of 10,000 square feet
- Parking provided on site in a surface parking area accessed from the alley
- Considers adjacency to existing single family scaled structures in a Lowrise zone

Existing LR1

Density limit	1 unit per 2000 sq. ft. of lot area
FAR maximum	1.2
Height limit	30 feet
Setbacks	
Front	5 feet
Rear	10 feet with alley 15 feet without alley
Sides	< 40' bldg: 5' > 40' bldg: 7' avg, 5' min.
Parking	1 per unit; no minimum in urban villages

LR1 Prototype – Existing

Lot size	5,000 sq. ft. x 2
Total allowed gross area	12,000 sq. ft.
Efficiency factor	0.8
Total net sq. ft.	9,600 sq. ft.
Maximum density	1 unit / 2,000 sq. ft. maximum 3 homes per lot
Total units	5
Average net unit size	1,900 sq. ft.
Parking spaces provided	11

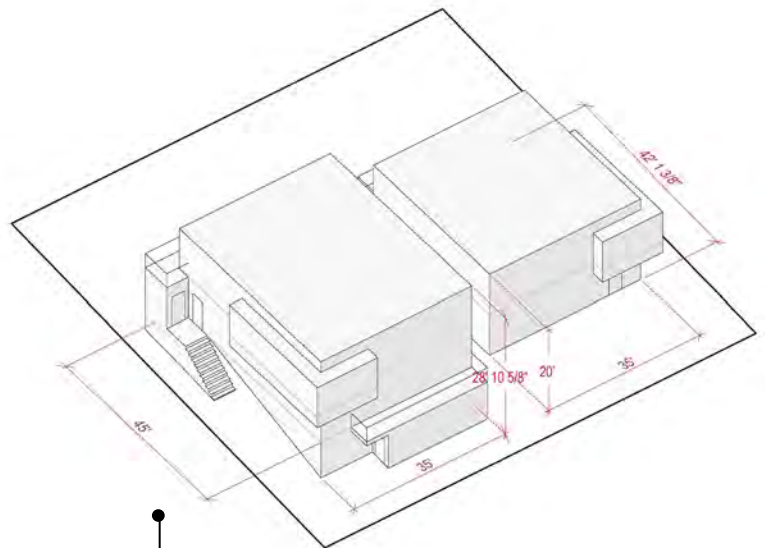

Affordable Homes

PERFORMANCE OPTION*

High MHA area (7%)	1.05 = 2 units
Medium MHA area (6%)	.90 = 1 unit
Low MHA area (5%)	.75 = 1 unit

PAYMENT OPTION

High MHA area (\$20.75/sq. ft.)	\$299,000
Med MHA area (\$13.25/sq. ft.)	\$191,000
Low MHA area (\$7/sq. ft.)	\$101,000

* If rounding down to provide affordable performance unit, developer must pay for the fraction they are rounding off as payment housing.

Proposed MHA LR1

Density limit	Family-sized unit requirement*
FAR maximum	1.3
Height limit	30 feet
Setbacks	
Front	5 feet
Rear	10 feet with alley 15 feet without alley
Sides	< 40' bldg: 5' > 40' bldg: 7' avg, 5' min.
Parking	1 per unit; no minimum in urban villages

LR1 Prototype – Proposed

Lot size	10,000 sq. ft.
Total allowed gross area	13,000 sq. ft.
Efficiency factor	0.8
Total net sq. ft.	10,400 sq. ft.
Area below grade	1,400 sq. ft.
Maximum density	Family-sized unit requirement*
Total units	15 (2 below grade)
Average net unit size	787 sq. ft.
Parking spaces provided	11

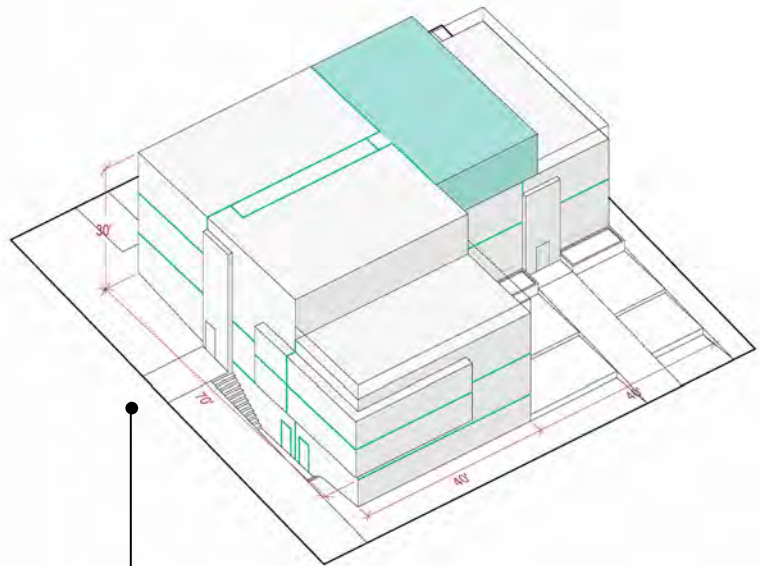

* For every 8 units, at least one 2-bedroom unit (min. 850 sq. ft.). For every 16 units, at least one 3-bedroom unit (min. 1,050 sq. ft.) or two 2-bedroom units (min. 850 sq. ft.)

LOWRISE 1 townhouses

Prototype Description

- An attached townhouse homeownership housing product
- A single 5,000-square-foot lot in an LR1 zone
- Parking provided for some units in a surface parking areas accessed from the alley
- Considers adjacency to existing single family scaled structures and other townhouses
- Increased FAR and new density limit requirements allow for variety of housing sizes

Existing LR1

Density limit	1 unit per 1600 sq. ft. (townhouse) No limit (rowhouse)
FAR maximum	1.2
Height limit	30 feet
Setbacks	
Front	5 feet
Rear	10 feet with alley 15 feet without alley
Sides	< 40' bldg: 5' > 40' bldg: 7' avg, 5' min.
Parking	1 per unit; no minimum in urban villages

LR1 Prototype – Existing

Lot size	5,000 sq. ft.
Total allowed gross area	6,000 sq. ft.
Efficiency factor	0.8
Total net sq. ft.	6,000 sq. ft.
Total units	4
Average net unit size	1,500 sq. ft.
Parking spaces provided	3

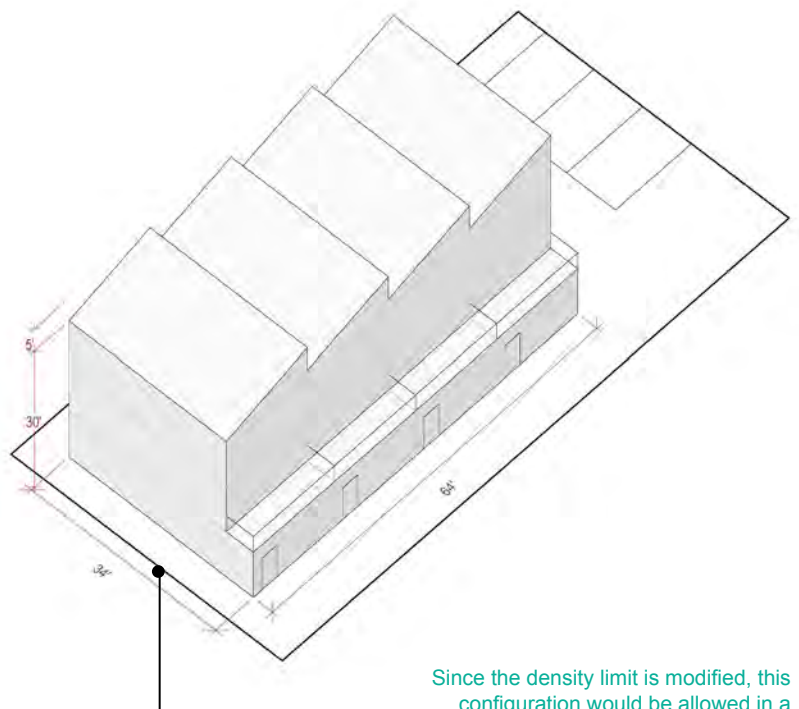

Since the density limit is modified, this configuration would be allowed in a rowhouse with unit entries facing the street in the existing zoning.

Affordable Homes

PERFORMANCE OPTION*

High MHA area (7%)	.35 = 1 unit
Medium MHA area (6%)	.30 = 1 unit
Low MHA area (5%)	.25 = 1 unit

PAYMENT OPTION

High MHA area (\$20.75/sq. ft.)	\$135,000
Medium MHA area (\$13.25/sq. ft.)	\$86,000
Low MHA area (\$7/sq. ft.)	\$46,000

* If rounding down to provide affordable performance unit, developer must pay for the fraction they are rounding off as payment housing.



Proposed MHA LR1

Density limit	Family-sized unit requirement*
FAR maximum	1.3
Height limit	30 feet
Setbacks	
Front	5 feet
Rear	10 feet with alley 15 feet without alley
Sides	< 40' bldg: 5' > 40' bldg: 7' avg, 5' min.
Parking	1 per unit; no minimum in urban villages

LR1 Prototype – Proposed

Lot size	5,000 sq. ft.
Total allowed gross area	6,500 sq. ft.
Efficiency factor	1
Total net sq. ft.	6,500 sq. ft.
Total units	5
Average net unit size	1,300 sq. ft.
Parking spaces provided	3

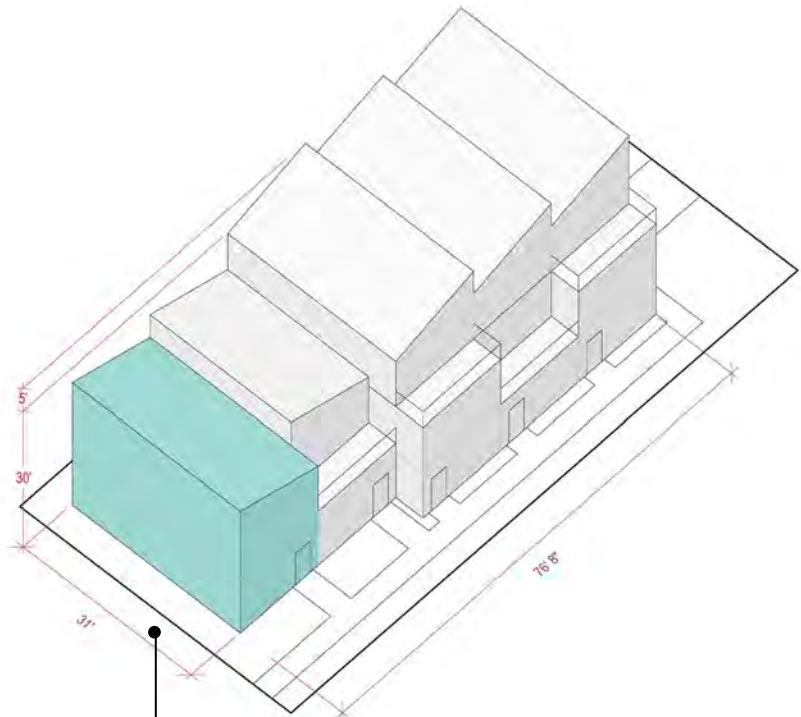

* For every 8 units, at least one 2-bedroom unit (min. 850 sq. ft.). For every 16 units, at least one 3-bedroom unit (min. 1,050 sq. ft.) or two 2-bedroom units (min. 850 sq. ft.)

LOWRISE 2

apartments | small site

Prototype Description

- An apartment or condominium housing product
- Two combined typically platted lots, for a total lot size of 10,000 square feet
- Parking provided for some units in a surface parking areas accessed from the alley
- Considers adjacency to smaller scale of existing single family structures and townhouses
- Upper level setbacks required when facing neighboring single family zones

Existing LR2

FAR maximum	1.3
Height limit	30 feet
Setbacks	
Front	5 feet
Rear	10 feet with alley 15 feet without alley
Sides	< 40' bldg: 5' > 40' bldg: 7' avg, 5' min.
Parking	1 per unit; no minimum in urban villages

LR2 Prototype – Existing

Lot size	10,000 sq. ft.
Total allowed gross area	13,000 sq. ft.
Efficiency factor	0.8
Total net sq. ft.	10,400 sq. ft.
Total units	16
Average net unit size	650 sq. ft.
Parking spaces provided	8

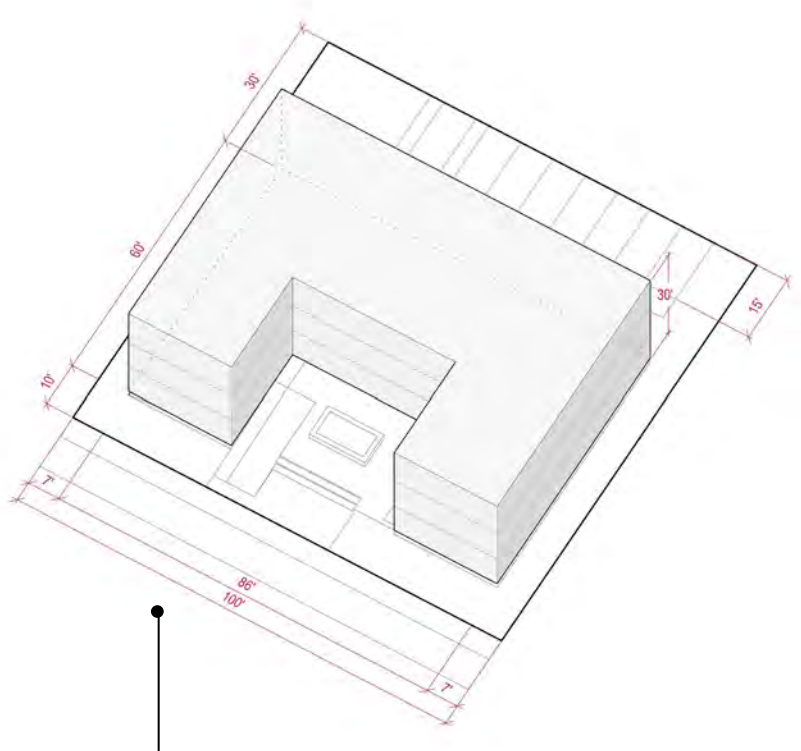

Affordable Homes

PERFORMANCE OPTION*

High MHA area (7%)	1.4 = 2 units
Medium MHA area (6%)	1.2 = 2 units
Low MHA area (5%)	1.0 = 1 unit

PAYMENT OPTION

High MHA area (\$20.75/sq. ft.)	\$311,000
Med MHA area (\$13.25/sq. ft.)	\$199,000
Low MHA area (\$7/sq. ft.)	\$105,000

* If rounding down to provide affordable performance unit, developer must pay for the fraction they are rounding off as payment housing.

Proposed MHA LR2

FAR maximum	1.5
Height limit	40 + 5 feet
Setbacks	
Front	5 feet
Upper	12 feet above 30 feet
Rear	10 feet with alley 15 feet without alley
Sides	< 40' bldg: 5' > 40' bldg: 7' avg, 5' min.
Parking	1 per unit; no minimum in urban villages

LR2 Prototype – Proposed

Lot size	10,000 sq. ft.
Total allowed gross area	15,000 sq. ft.
Efficiency factor	0.8
Total net sq. ft.	12,000 sq. ft.
Total units	20
Average net unit size	600 sq. ft.
Parking spaces provided	8

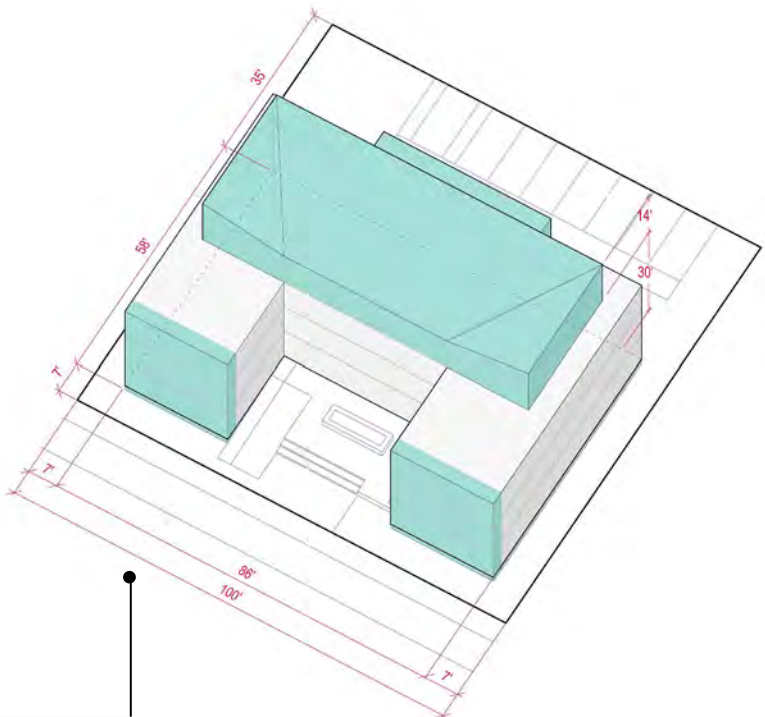
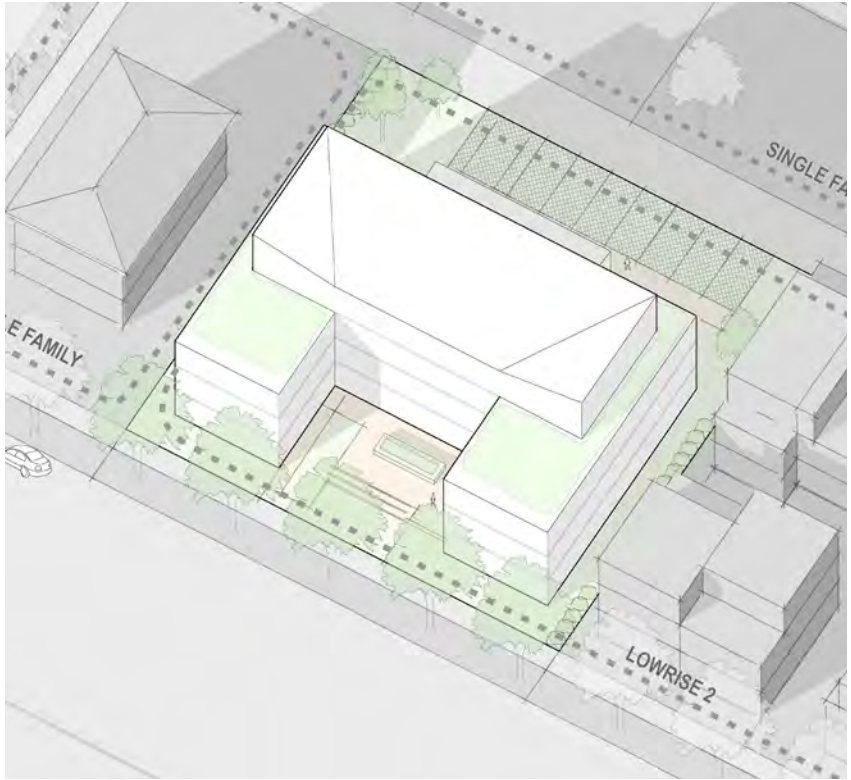

LOWRISE 2

apartments | large site

Prototype Description

- An apartment or condominium housing product.
- Three combined typically platted lots, for a total lot size of 15,000 square feet.
- Parking is provided for some of the units in a surface parking areas accessed from the alley.
- Considers adjacency to smaller existing single family scaled structures and townhouses.

Existing LR2

FAR maximum	1.3
Height limit	30 feet
Setbacks	
Front	5 feet
Rear	10 feet with alley 15 feet without alley
Sides	< 40' bldg: 5' > 40' bldg: 7' avg, 5' min.
Parking	1 per unit; no minimum in urban villages

LR2 Prototype – Existing

Lot size	15,000 sq. ft.
Total allowed gross area	19,500 sq. ft.
Efficiency factor	0.8
Total net sq. ft.	15,600 sq. ft.
Total units	24
Average net unit size	650 sq. ft.
Parking spaces provided	16

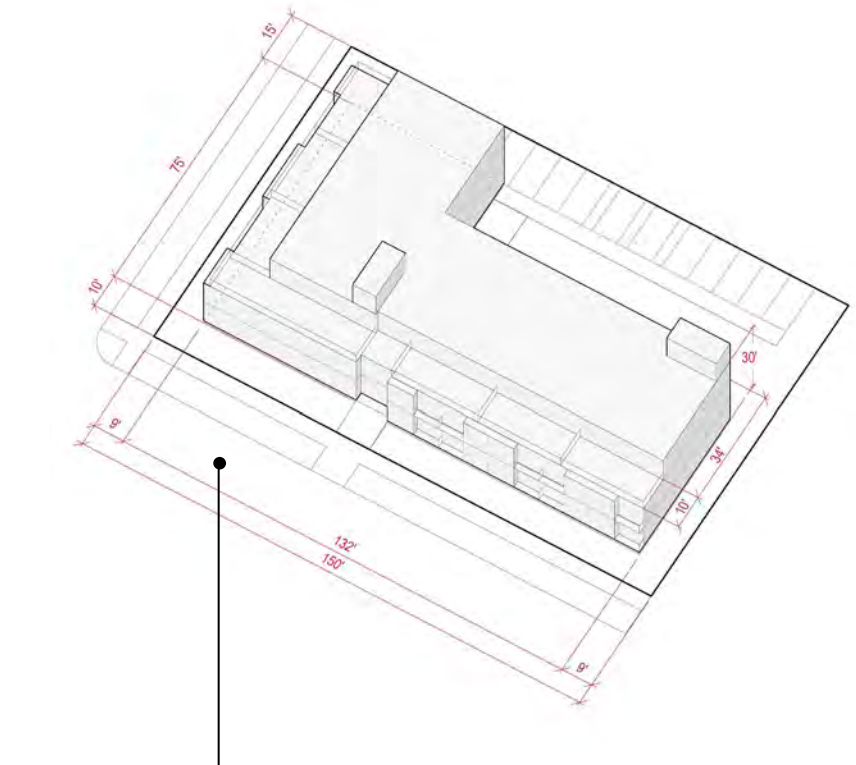

Affordable Homes

PERFORMANCE OPTION*

High MHA area (7%)	1.82 = 2 units
Medium MHA area (6%)	1.56 = 2 units
Low MHA area (5%)	1.30 = 2 units

PAYMENT OPTION

High MHA area (\$20.75/sq. ft.)	\$467,000
Med MHA area (\$13.25/sq. ft.)	\$298,000
Low MHA area (\$7/sq. ft.)	\$158,000

* If rounding down to provide affordable performance unit, developer must pay for the fraction they are rounding off as payment housing.

Proposed MHA LR2

FAR maximum	1.5
Height limit	40 + 5 feet
Setbacks	
Front	5 feet
Upper	12 feet above 30 feet
Rear	10 feet with alley 15 feet without alley
Sides	< 40' bldg: 5' > 40' bldg: 7' avg, 5' min.
Parking	1 per unit; no minimum in urban villages

LR2 Prototype – Proposed

Lot size	15,000 sq. ft.
Total allowed gross area	22,500 sq. ft.
Efficiency factor	0.8
Total net sq. ft.	18,000 sq. ft.
Total units	26
Average net unit size	692 sq. ft.
Parking spaces provided	16

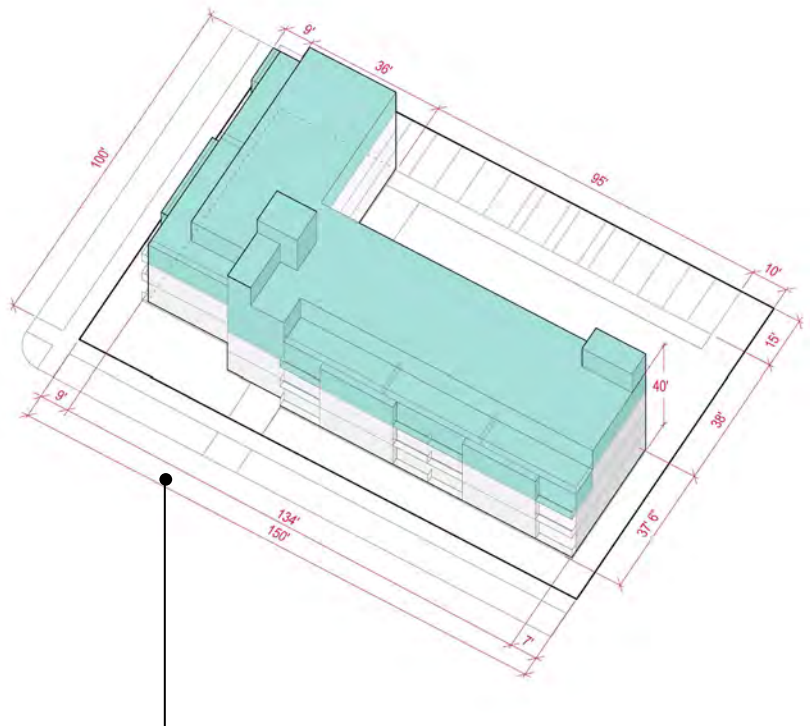

LOWRISE 2 townhouses

Prototype Description

- An attached townhouse homeownership housing product.
- Two combined typically platted lots, for a total lot size of 10,000 square feet.
- Parking is provided for some of the units within structures accessed from the alley.
- Considers adjacency to smaller existing single family scaled structures and townhouses.

Existing LR2

FAR maximum	1.3
Height limit	30 + 5 feet
Setbacks	
Front	7' avg, 5' min
Rear	7' avg, 5' min
Sides	< 40' bldg: 5' > 40' bldg: 7' avg, 5' min.
Parking	1 per unit; no minimum in urban villages

LR2 Prototype – Existing

Lot size	10,000 sq. ft.
Total allowed gross area	12,000 sq. ft.
Efficiency factor	1
Total net sq. ft.	12,000 sq. ft.
Total units	8
Average net unit size	1,500 sq. ft.
Parking spaces provided	6

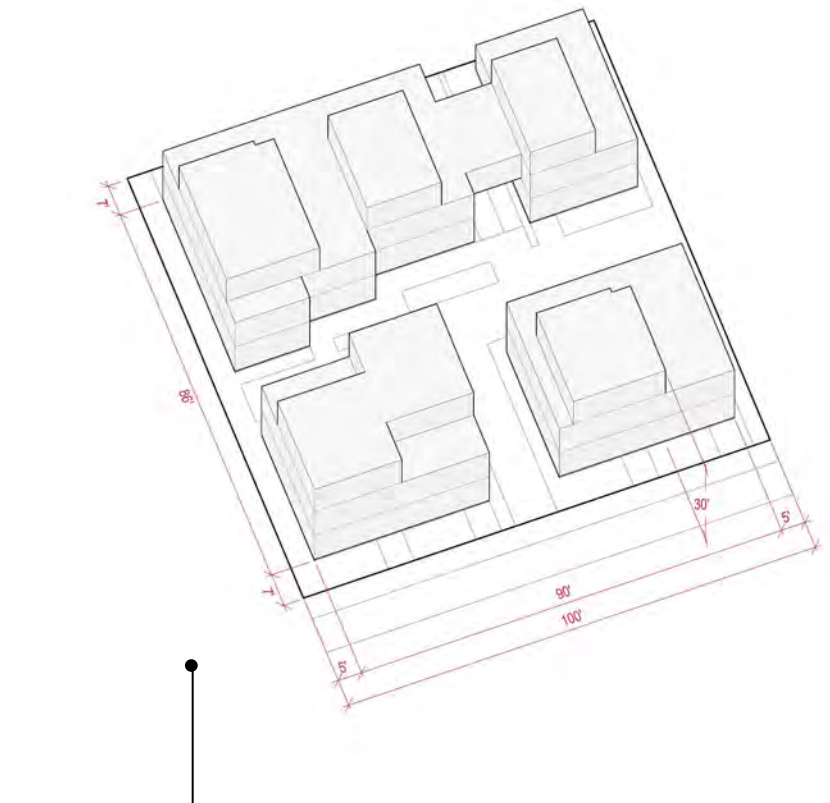

Affordable Homes

PERFORMANCE OPTION*

High MHA area (7%)	.56 = 1 unit
Medium MHA area (6%)	.48 = 1 unit
Low MHA area (5%)	.40 = 1 unit

PAYMENT OPTION

High MHA area (\$20.75/sq. ft.)	\$291,000
Med MHA area (\$13.25/sq. ft.)	\$186,000
Low MHA area (\$7/sq. ft.)	\$98,000

* If rounding down to provide affordable performance unit, developer must pay for the fraction they are rounding off as payment housing.

Proposed MHA LR2

FAR maximum	1.4
Height limit	40 + 5 feet
Setbacks	
Front	7' avg, 5' min
Upper	12 feet above 30 feet
Rear	7' avg, 5' min
Sides	< 40' bldg: 5' > 40' bldg: 7' avg, 5' min.
Parking	1 per unit; no minimum in urban villages

LR2 Prototype – Proposed

Lot size	10,000 sq. ft.
Total allowed gross area	14,000 sq. ft.
Efficiency factor	1
Total net sq. ft.	14,000 sq. ft.
Total units	8
Average net unit size	1,750 sq. ft.
Parking spaces provided	6

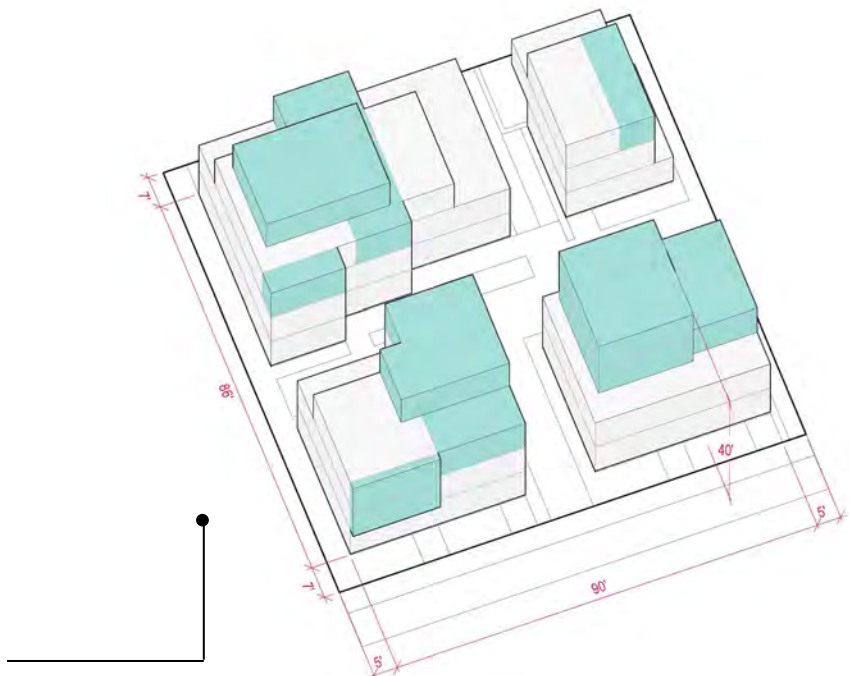

LOWRISE 3

apartments | small site

Prototype Description

- An apartment or condominium housing product.
- A typically platted lot, for a total lot size of 5,000 square feet.
- Parking is provided for some of the units in a surface parking areas accessed from the alley.
- Considers adjacency to smaller existing single family scaled structures and townhouses.

Existing LR3

FAR maximum	2.0
Height limit	40 feet
Setbacks	
Front	5 feet
Rear	10 feet with alley 15 feet without alley
Sides	< 40' bldg: 5' > 40' bldg: 7' avg, 5' min.
Parking	1 per unit; no minimum in urban villages

LR3 Prototype – Existing

Lot size	5,000 sq. ft.
Total allowed gross area	10,000 sq. ft.
Efficiency factor	0.8
Total net sq. ft.	8,000 sq. ft.
Total units	10
Average net unit size	800 sq. ft.
Parking spaces provided	5

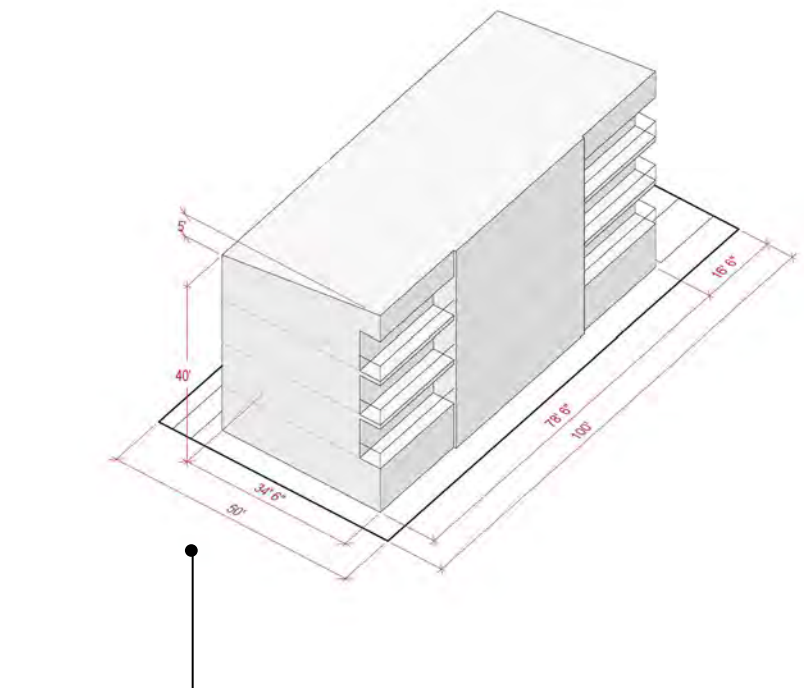

Affordable Homes

PERFORMANCE OPTION*

High MHA area (7%)	.98 = 1 unit
Medium MHA area (6%)	.84 = 1 unit
Low MHA area (5%)	.70 = 1 unit

PAYMENT OPTION

High MHA area (\$20.75/sq. ft.)	\$228,000
Med MHA area (\$13.25/sq. ft.)	\$146,000
Low MHA area (\$7/sq. ft.)	\$77,000

* If rounding down to provide affordable performance unit, developer must pay for the fraction they are rounding off as payment housing.

Proposed MHA LR3

FAR maximum	2.2
Height limit	50 feet
Setbacks	
Front	5 feet
Upper	12 feet above 40 feet
Rear	10 feet with alley 15 feet without alley
Sides	< 40' bldg: 5' > 40' bldg: 7' avg, 5' min.
Parking	1 per unit; no minimum in urban villages

LR3 Prototype – Proposed

Lot size	5,000 sq. ft.
Total allowed gross area	11,000 sq. ft.
Efficiency factor	0.8
Total net sq. ft.	8,800 sq. ft.
Total units	14
Average net unit size	650 sq. ft.
Parking spaces provided	5

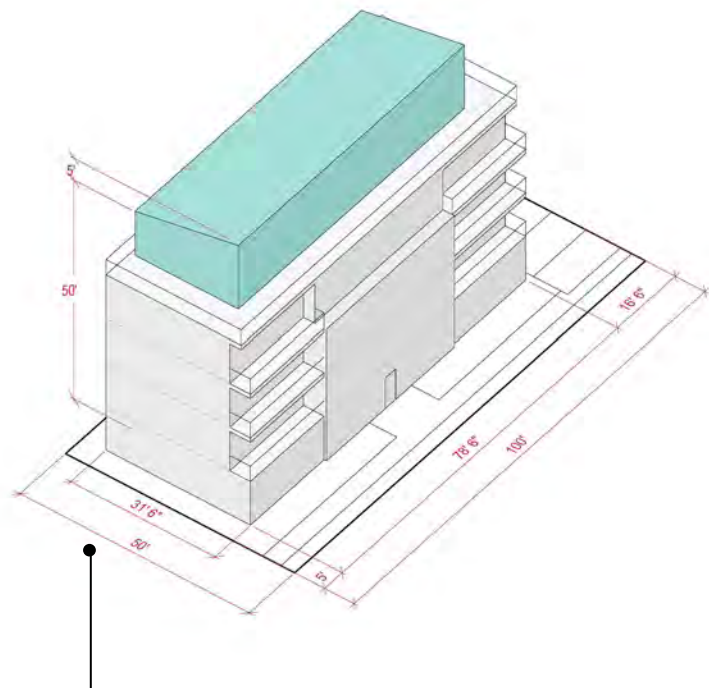

LOWRISE 3

apartments | large site

Prototype Description

- An apartment or condominium housing product.
- Three combined typically platted lots, for a total lot size of 15,000 square feet.
- Parking is provided for some of the units in a surface parking areas accessed from the alley.
- Considers adjacency to smaller existing single family scaled structures and townhouses.

Existing LR3

FAR maximum	2.0
Height limit	40 feet
Setbacks	
Front	5 feet
Rear	10 feet with alley 15 feet without alley
Sides	< 40' bldg: 5' > 40' bldg: 7' avg, 5' min.
Parking	1 per unit; no minimum in urban villages

LR3 Prototype – Existing

Lot size	15,000 sq. ft.
Total allowed gross area	30,000 sq. ft.
Efficiency factor	0.8
Total net sq. ft.	24,000 sq. ft.
Area below grade	7,000 sq. ft.
Total units	48 (10 below)
Average net unit size	650 sq. ft.
Parking spaces provided	12

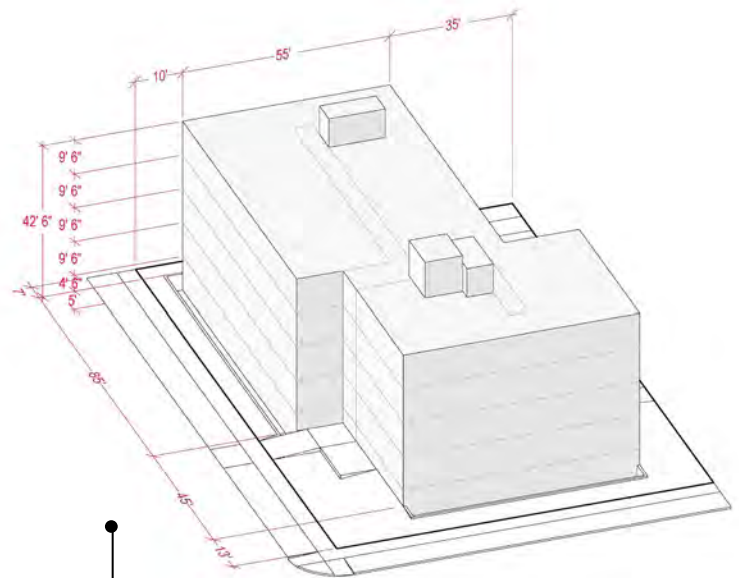

Affordable Homes

PERFORMANCE OPTION*

High MHA area (7%)	3.57 = 4 units
Medium MHA area (6%)	3.06 = 4 units
Low MHA area (5%)	2.55 = 3 units

PAYMENT OPTION

High MHA area (\$20.75/sq. ft.)	\$830,000
Med MHA area (\$13.25/sq. ft.)	\$530,000
Low MHA area (\$7/sq. ft.)	\$280,000

* If rounding down to provide affordable performance unit, developer must pay for the fraction they are rounding off as payment housing.

Proposed MHA LR3

FAR maximum	2.2
Height limit	50 feet
Setbacks	
Front	5 feet
Upper	12 feet above 40 feet
Rear	10 feet with alley 15 feet without alley
Sides	< 40' bldg: 5' > 40' bldg: 7' avg, 5' min.
Parking	1 per unit; no minimum in urban villages

LR3 Prototype – MHA

Lot size	15,000 sq. ft.
Total allowed gross area	33,000 sq. ft.
Efficiency factor	0.8
Total net sq. ft.	26,400 sq. ft.
Area below grade	7,000 sq. ft.
Total units	51 (10 below)
Average net unit size	650 sq. ft.
Parking spaces provided	12

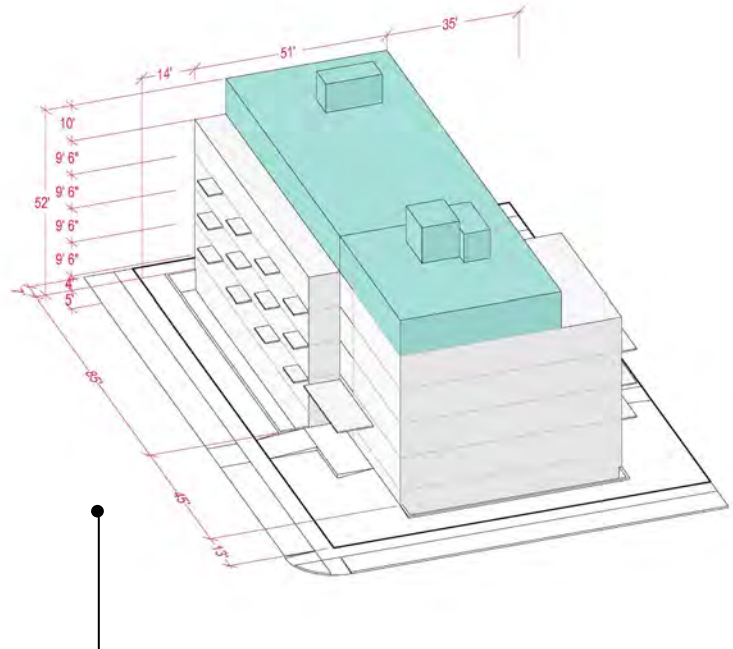
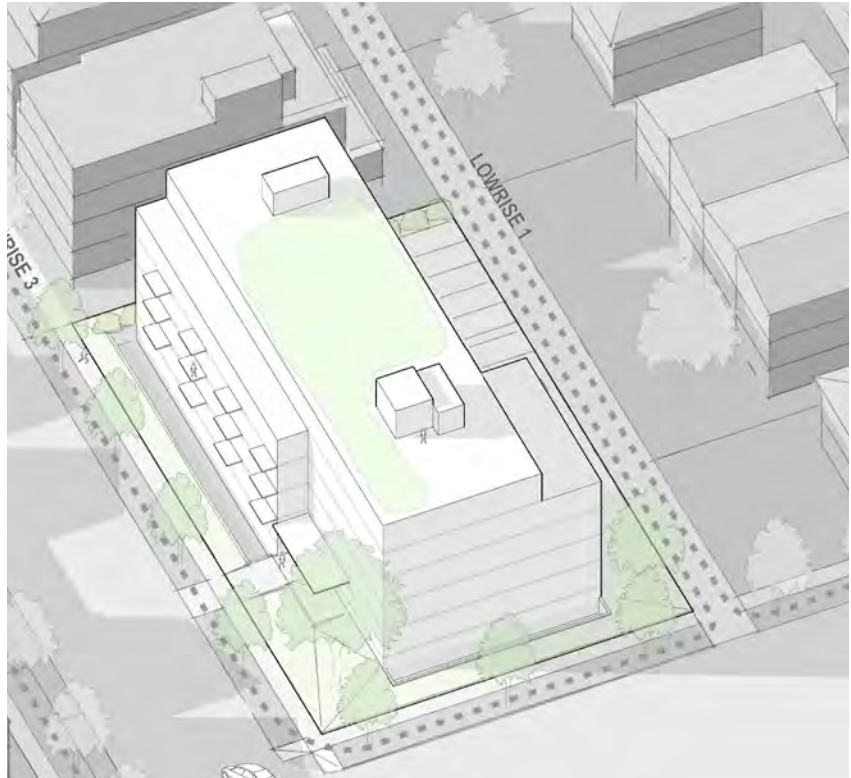

LOWRISE 3

apartment-style rowhouses

Prototype Description

- An apartment or condominium housing product.
- A typically platted lot, for a total lot size of 5,000 square feet.
- Considers adjacency to smaller existing single family scaled structures and townhouses.
- Allows for a larger rear yard setback when facing single family houses

Existing LR3

FAR maximum	2.0
Height limit	40 feet
Setbacks	
Front	5 feet
Rear	10 feet with alley 15 feet without alley
Sides	< 40' bldg: 5' > 40' bldg: 7' avg, 5' min.
Parking	1 per unit; no minimum in urban villages

LR3 Prototype – Existing

Lot size	5,000 sq. ft.
Total allowed gross area	10,000 sq. ft.
Efficiency factor	0.8
Total net sq. ft.	8,000 sq. ft.
Total units	10
Average net unit size	800 sq. ft.
Parking spaces provided	0

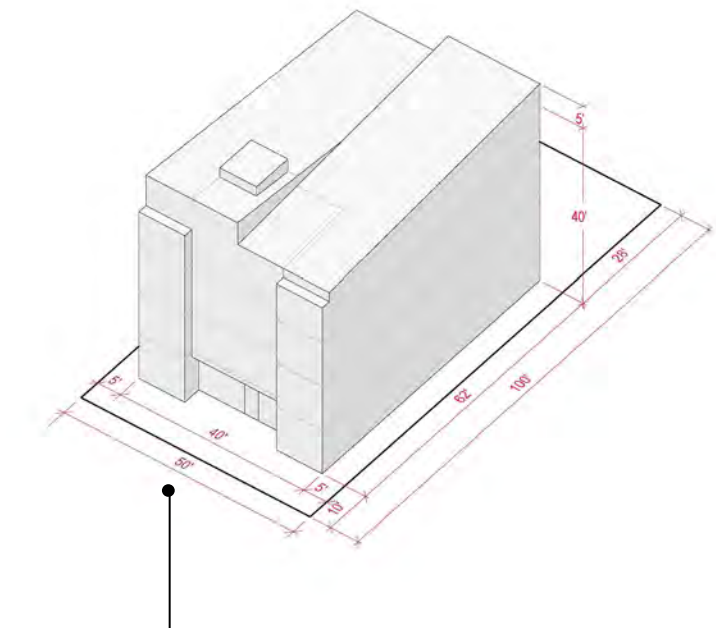

Affordable Homes

PERFORMANCE OPTION*

High MHA area (7%)	0.98 = 1 unit
Medium MHA area (6%)	0.84 = 1 unit
Low MHA area (5%)	0.70 = 1 unit

PAYMENT OPTION

High MHA area (\$20.75/sq. ft.)	\$228,000
Med MHA area (\$13.25/sq. ft.)	\$146,000
Low MHA area (\$7/sq. ft.)	\$77,000

* If rounding down to provide affordable performance unit, developer must pay for the fraction they are rounding off as payment housing.

Proposed MHA LR3

FAR maximum	2.2
Height limit	50 feet
Setbacks	
Front	5 feet
Upper	12 feet above 40 feet
Rear	10 feet with alley 15 feet without alley
Sides	n/a
Parking	1 per unit; no minimum in urban villages

LR3 Prototype – MHA

Lot size	5,000 sq. ft.
Total allowed gross area	11,000 sq. ft.
Efficiency factor	0.8
Total net sq. ft.	8,800 sq. ft.
Total units	14
Average net unit size	629 sq. ft.
Parking spaces provided	0

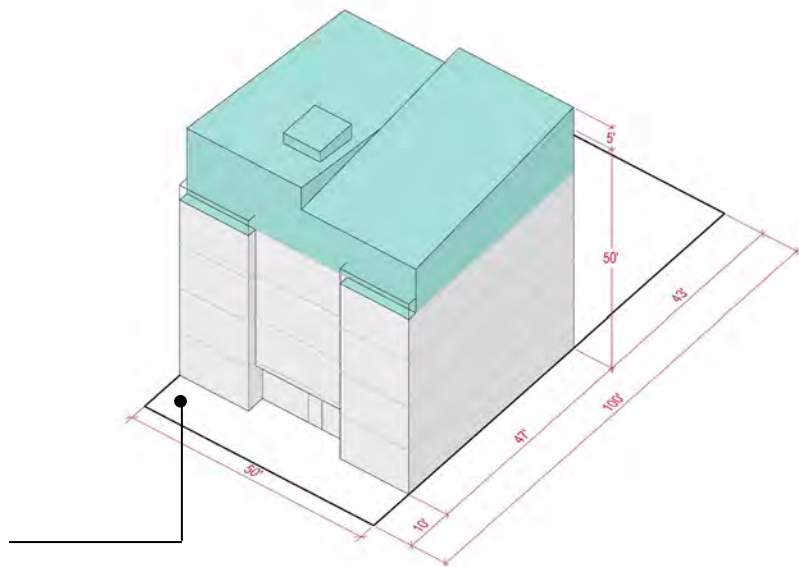
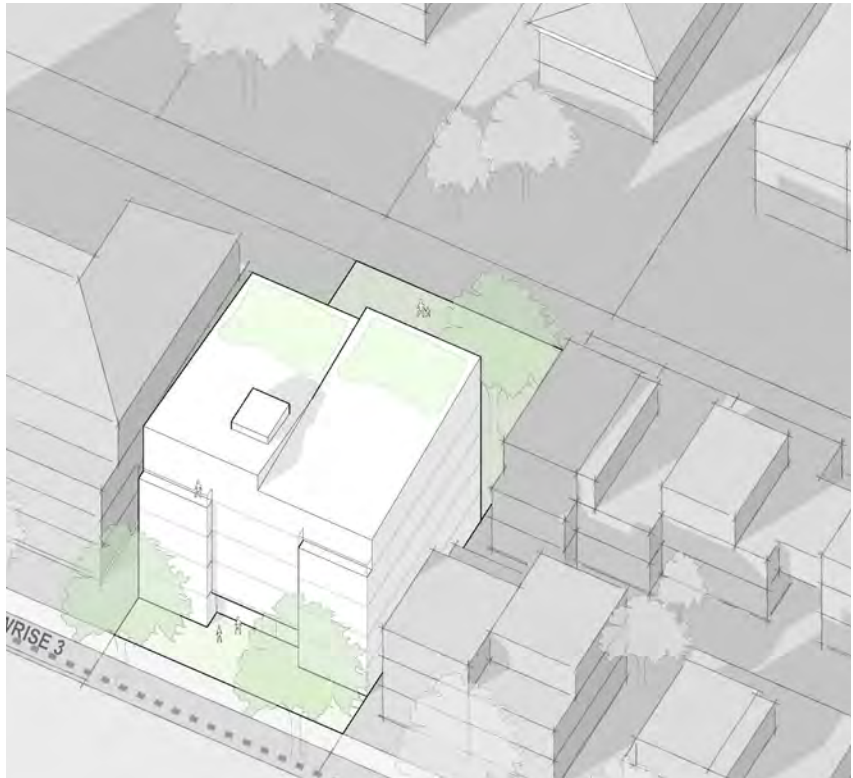

The alternative explores a rowhouse development type where side setbacks are removed. Design standards would ensure that the building is configured as a rowhouse development.

Includes form characteristics of a rowhouse but in stacked apartments

Light and air requirements are not compromised in the units facing the deeper rear yard when compared to units facing side yards.

LR Zone - Urban Design and Neighborhood Character

Livability Benefits

- LR zones provide a transition between higher intensity neighborhood commercial areas and RSL or Single Family zones.
- LR zones encourage ground-related housing in a variety of formats and densities close to transit and amenities.
- LR zones provide a mix of homeownership and rental housing opportunities.
- LR zones provide a range of multifamily and attached housing options in urban village locations.
- Urban design standards are proposed for privacy, and design interest to address the edges of LR zones.



Lowrise 2 provides a transition between higher-intensity areas and single family zones.



Lowrise zones are often located close to transit and amenities such as parks and shops.

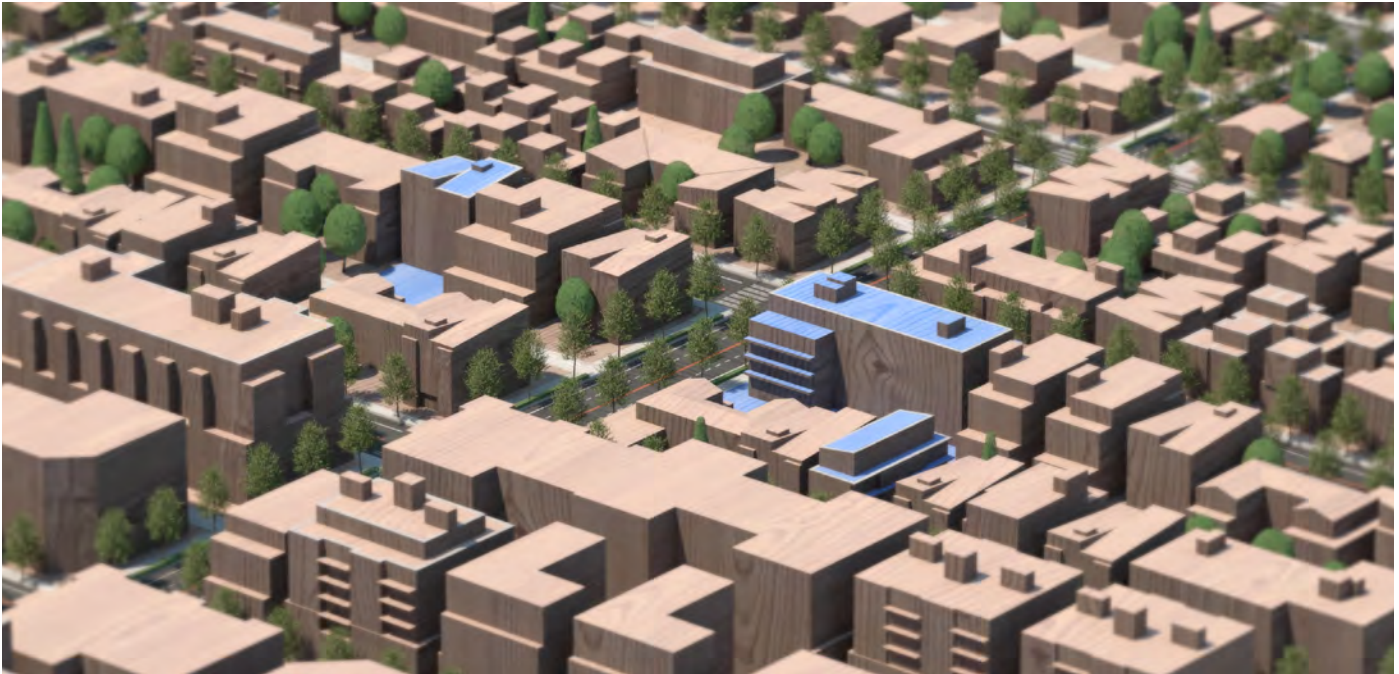

Lowrise zones encourage ground-related housing in a variety of formats and densities.



Urban design standards are proposed for privacy and design interest to address the edges of Lowrise zones.

Proposed Development and Urban Design Standards

The table below summarizes other proposed or modified development standards intended to improve an urban design outcome and improve livability with new development in the zone.

Issue / Intent	Lowrise Zone	Proposed / Modified Development Standard
Allow variety of housing options, and ensure variety of housing unit sizes.	LR1	Remove the density limit for apartment housing types in the LR1 zone. For every 7 small units of 400 sf or less, an eighth 2BR unit at least 850 sf; or Up to 13 small units of 400 sf or less can be built if a 3BR unit of at least 1,100 sf is included
Increase design flexibility and provide development capacity to implement MHA.	LR1, LR2, LR3	Projects would no longer be required to meet additional design standards for parking location and access to achieve higher FAR amounts and density limits in LR zones. Green building performance requirements would continue to apply.
Ensure light and air access to public rights of way, and compatibility of street facing building scale, as height limits are increased.	LR2, LR3	Retain an upper level setback of 12' feet from a street facing property line for portions of the facade at heights of 30' and above in the LR2 zone. Retain an upper level setback of 12' feet from a street facing property line for portions of the facade at heights of 40' and above in the LR3 zone.
Address transitions and adjacencies at zone edges.	LR1, LR2, LR3	Add minimum design standards for side facade configuration and design, for development on a zone edge between more intensive and less intensive zones, including adjacency to single family zones. The design standard would address two factors: 1.) privacy (i.e. window placement or screening), and 2.) minimum modulation or design interest to deter large blank facades. Standards are departable through design review.
Retain design flexibility and provide development capacity to implement MHA.	LR1, LR2, LR3	Retain the existing FAR exemption for residential uses in partially below grade basements in the LR2, and LR3 zones. Allow an FAR exemption for residential use in partially below grade basement in the LR1 zone.

Neighborhood Commercial (NC)

Community Input Themes

- In general, the height limit and floor area increases are incremental and a good tradeoff for the affordable housing requirement.
- Some of the largest buildings are bulky. Consider ways to keep buildings a manageable size and at human-scale.
- Incorporate open spaces and courtyards where possible.
- Neighborhood Commercial zones allow for large quantities of housing to be produced, they are a good tool for housing and affordable housing production.

Zoning Prototypes

The following pages discuss the Neighborhood Commercial NC-40, NC-55, NC-75 and NC-95 zones.

Commercial Zones

Neighborhood Commercial zones address scale and massing issues of Commercial zones, which have identical maximum FAR and height limits.

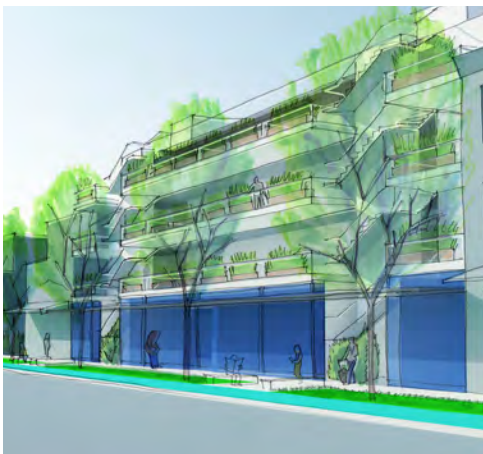

NC-40
small site



NC-75
small site







NC-95
5-over-3
construction

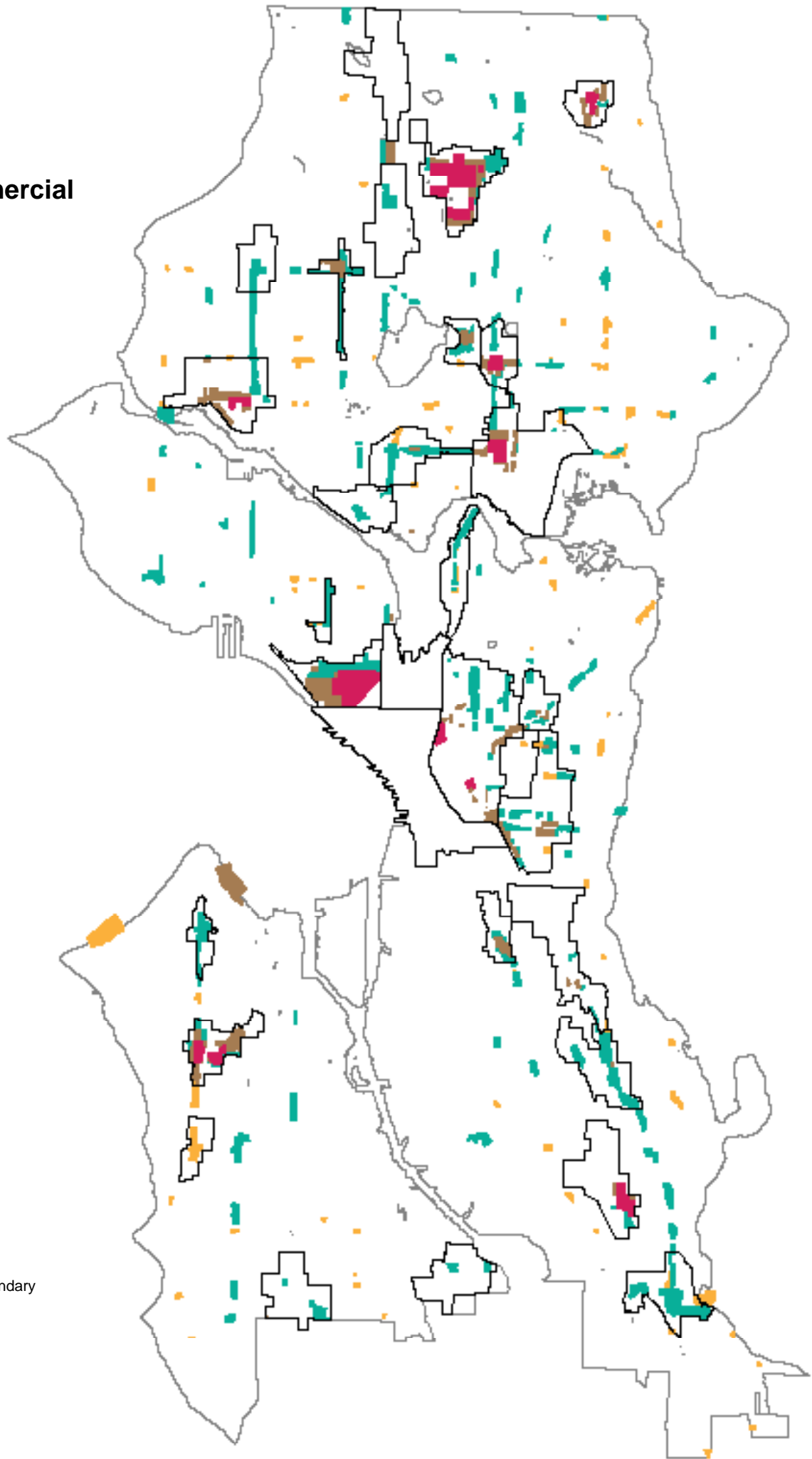

NC-75
large site

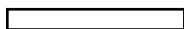
**Location of existing
Neighborhood Commercial
zones**



-  Urban Village Boundary
-  Existing NC-30
-  Existing NC-40
-  Existing NC-65
-  Existing NC-85

Neighborhood Commercial 40 small site

Prototype Description:

- An apartment or condominium housing product.
- Total lot size of 12,000 square feet.
- Considers adjacency to smaller Lowrise zones.
- Has street-level retail space.

Existing NC-30

FAR maximum	2.5
Height limit	30 feet
Setbacks	
Front	First floor dwellings must be 4 feet above or 10 feet back from street
Rear	10 feet if next to residential zone
Sides	15 feet if next to residential zone
Parking	1 per unit; no minimum in urban villages

NC-30 Prototype – Existing

Lot size	12,000 sq. ft.
Total allowed gross area	30,000 sq. ft.
Efficiency factor	0.8
Ground-floor commercial	4,000 sq. ft.
Total net residential	20,800 sq. ft.
Total units	29
Average net unit size	711 sq. ft.
Parking spaces provided	0

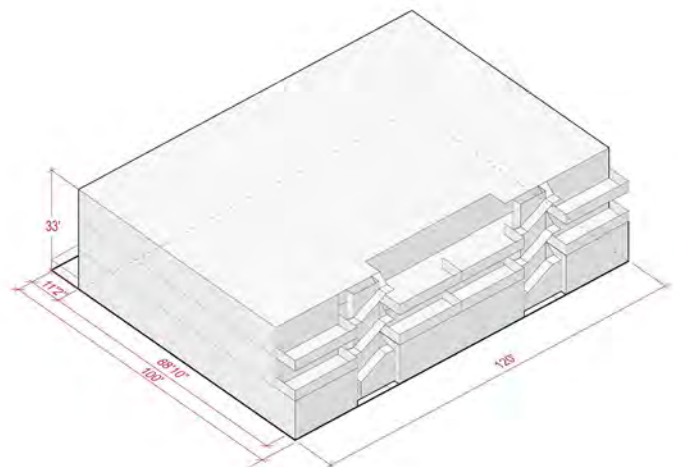

Affordable Homes

PERFORMANCE OPTION* (+ commercial addition)

High MHA area (7%)	2.52 (+ 0) = 3 units
Medium MHA area (6%)	2.16 (+ 0) = 3 units
Low MHA area (5%)	1.80 (+ 0) = 2 units

PAYMENT OPTION

High MHA area (\$20.75/sq. ft.)	\$664k (+ 0) = \$664,000
Med MHA area (\$13.25/sq. ft.)	\$424k (+ 0) = \$424,000
Low MHA area (\$7/sq. ft.)	\$224k (+ 0) = \$224,000

* If rounding down to provide affordable performance unit, developer must pay for the fraction they are rounding off as payment housing.

The first 4,000 sf of ground floor commercial does not count towards MHA requirements

Proposed MHA NC-40

FAR maximum	3.0
Height limit	40 feet
Setbacks	
Front	First floor dwellings must be 4 feet above or 10 feet back from street
Rear	10 feet if next to residential zone
Sides	15 feet if next to residential zone
Parking	1 per unit; no minimum in urban villages

NC-40 Prototype – Proposed

Lot size	12,000 sq. ft.
Total allowed gross area	36,000 sq. ft.
Efficiency factor	0.8
Ground-floor commercial	4,000 sq. ft.
Total net residential	25,600 sq. ft.
Total units	36 (A) / 18 (B)
Avg. unit size	689 (A) / 1,108 (B) sq. ft.
Parking spaces provided	0

NEIGHBORHOOD COMMERCIAL (NC)

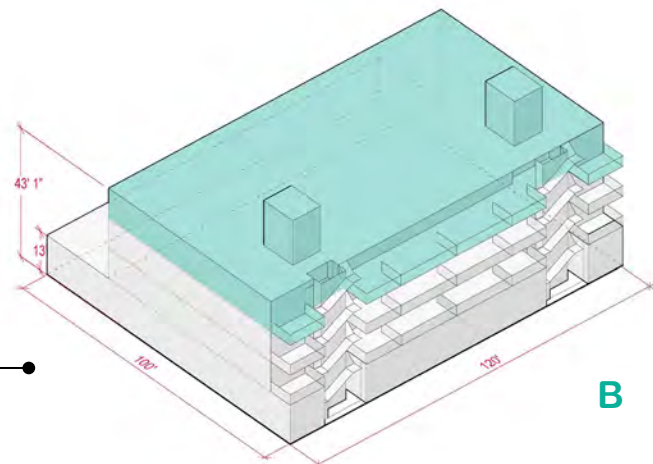
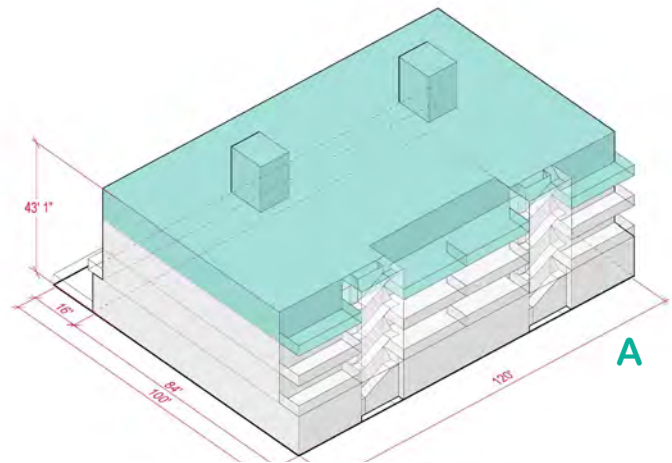
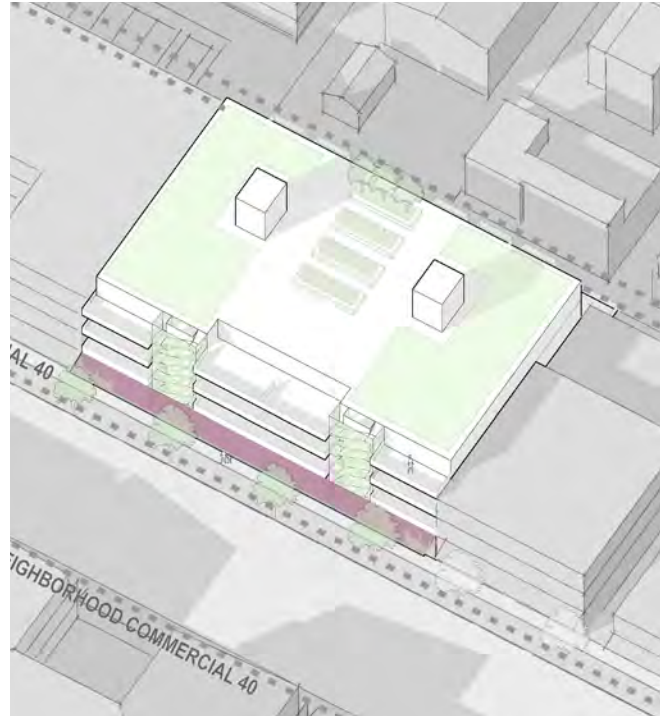

Neighborhood Commercial 40 mixed-use | large site

Prototype Description

- An apartment or condominium housing product.
- Total lot size of 16,000 square feet.
- Underground parking provided for some of the units.
- Considers adjacency to smaller Lowrise zones.
- Has street-level retail space.
- Has a break in the building mass at the upper level.

Existing NC-30

FAR maximum	2.5
Height limit	30 feet
Setbacks	
Front	First floor dwellings must be 4 feet above or 10 feet back from street
Rear	10 feet if next to residential zone
Sides	15 feet if next to residential zone
Parking	1 per unit; no minimum in urban villages

NC-30 Prototype – Existing

Lot size	16,000 sq. ft.
Total allowed gross area	40,000 sq. ft.
Efficiency factor	0.8
Ground-floor commercial	5,600 sq. ft.
Total net residential	27,520 sq. ft.
Total units	33
Average net unit size	827 sq. ft.
Parking spaces provided	underground

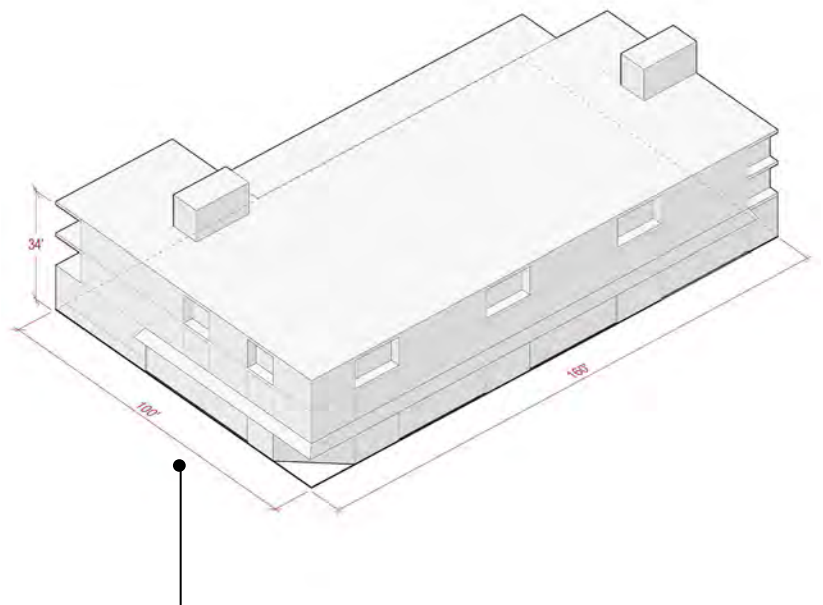

Affordable Homes

PERFORMANCE OPTION* (+ commercial addition)

High MHA area (7%)	2.87 (+ .10) = 3 units
Medium MHA area (6%)	2.46 (+ .10) = 3 units
Low MHA area (5%)	2.05 (+ .10) = 3 units

PAYMENT OPTION

High MHA area (\$20.75/sq. ft.)	\$880k (+ \$13k) = \$893,000
Med MHA area (\$13.25/sq. ft.)	\$562k (+ \$11k) = \$573,000
Low MHA area (\$7/sq. ft.)	\$297k (+ \$8k) = \$305,000

* If rounding down to provide affordable performance unit, developer must pay for the fraction they are rounding off as payment housing.

The first 4,000 sf of ground floor commercial does not count towards MHA requirements



Proposed MHA NC-40

FAR maximum	3.0
Height limit	40 feet
Setbacks	
Front	First floor dwellings must be 4 feet above or 10 feet back from street
Rear	10 feet if next to residential zone
Sides	15 feet if next to residential zone
Parking	1 per unit; no minimum in urban villages

NC-40 Prototype – MHA

Lot size	16,000 sq. ft.
Total allowed gross area	48,000 sq. ft.
Efficiency factor	0.8
Ground-floor commercial	5,600 sq. ft.
Total net residential	33,920 sq. ft.
Total units	41
Average net unit size	827 sq. ft.
Parking spaces provided	underground

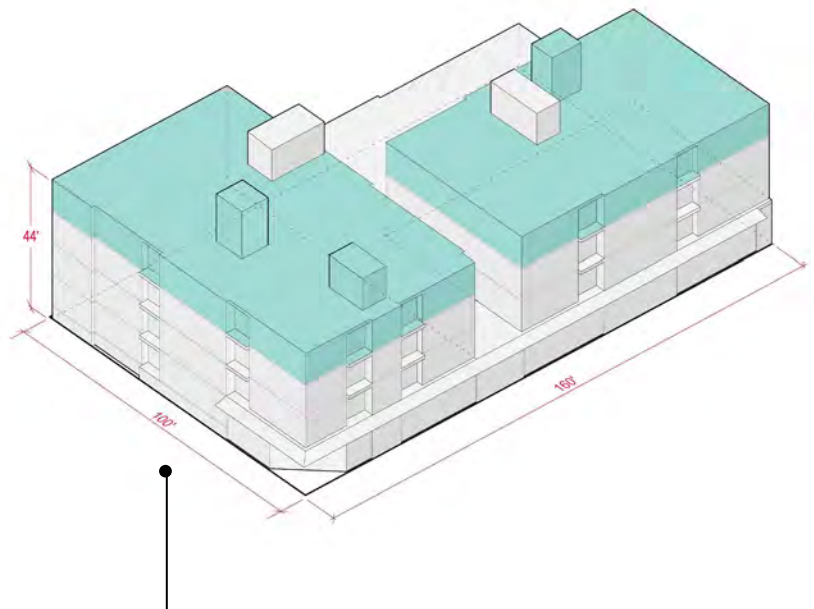

Neighborhood Commercial 55 mixed-use | small site

Prototype Description

- An apartment or condominium housing product.
- Total lot size of 15,000 square feet.
- Underground parking provided for some of the units.
- Considers adjacency to smaller Lowrise zones.
- Has street-level retail space.

Existing NC-40

FAR maximum	3.25
Height limit	40 feet
Setbacks	
Front	First floor dwellings must be 4 feet above or 10 feet back from street
Rear	10 feet if next to residential zone
Sides	15 feet if next to residential zone
Parking	1 per unit; no minimum in urban villages

NC-40 Prototype – Existing

Lot size	15,000 sq. ft.
Total allowed gross area	48,750 sq. ft.
Efficiency factor	0.8
Ground-floor commercial	5,000 sq. ft.
Total net residential	35,000 sq. ft.
Total units	40
Average net unit size	875 sq. ft.
Parking spaces provided	underground

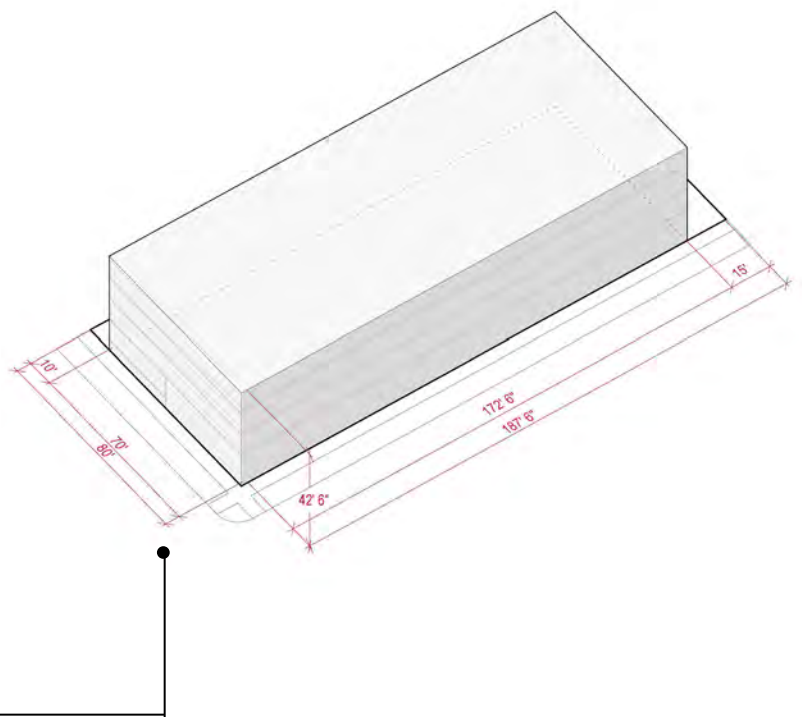

Affordable Homes

PERFORMANCE OPTION* (+ commercial addition)

High MHA area (7%)	3.64 (+ .09) = 4 units
Medium MHA area (6%)	3.12 (+ .09) = 4 units
Low MHA area (5%)	2.60 (+ .09) = 3 units

PAYMENT OPTION

High MHA area (\$20.75/sq. ft.)	\$1,063k (+ \$8k) = \$1,071,000
Med MHA area (\$13.25/sq. ft.)	\$679k (+ \$7k) = \$686,000
Low MHA area (\$7/sq. ft.)	\$359k (+ \$5k) = \$364,000

Proposed MHA NC-55

FAR maximum	3.75
Height limit	55 feet
Setbacks	
Front	First floor dwellings must be 4 feet above or 10 feet back from street
Upper	Avg. depth of 5 feet, max. depth of 15 feet above 45 feet
Rear	10 feet if next to residential zone
Sides	15 feet if next to residential zone
Façade modulation	Change of materials or a min. 18-inch-deep modulation at a min. of every 50 feet
Parking	1 per unit; no minimum in urban villages

NC-55 Prototype – MHA

Lot size	15,000 sq. ft.
Total allowed gross area	56,250 sq. ft.
Efficiency factor	0.8
Ground-floor commercial	5,000 sq. ft.
Total net residential	41,000 sq. ft.
Total units	52
Average net unit size	788 sq. ft.
Parking spaces provided	underground

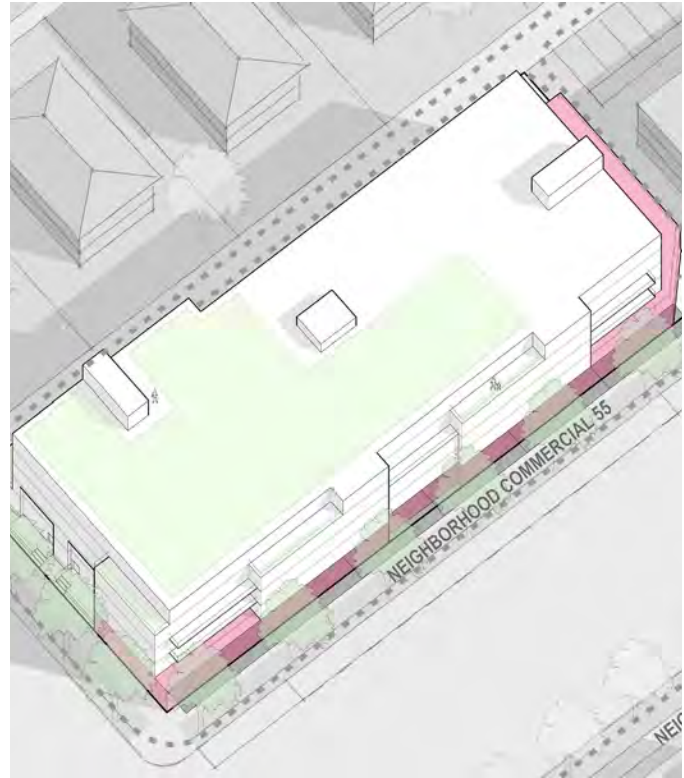

* If rounding down to provide affordable performance unit, developer must pay for the fraction they are rounding off as payment housing.

The first 4,000 sf of ground floor commercial does not count towards MHA requirements

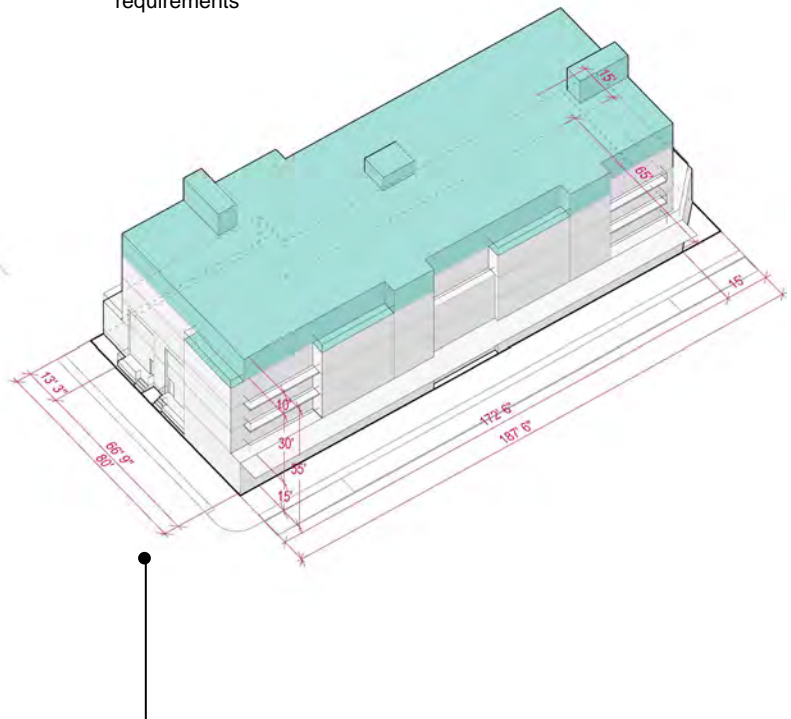

Neighborhood Commercial 55 mixed-use | large site

Prototype Description

- An apartment or condominium housing product.
- Total lot size of 18,000 square feet.
- Underground parking provided for some of the units.
- Considers adjacency to smaller Lowrise zones.
- Has street-level retail space.

Existing NC-40

FAR maximum	3.25
Height limit	40 feet
Setbacks	
Front	First floor dwellings must be 4 feet above or 10 feet back from street
Rear	10 feet if next to residential zone
Sides	15 feet if next to residential zone
Parking	1 per unit; no minimum in urban villages

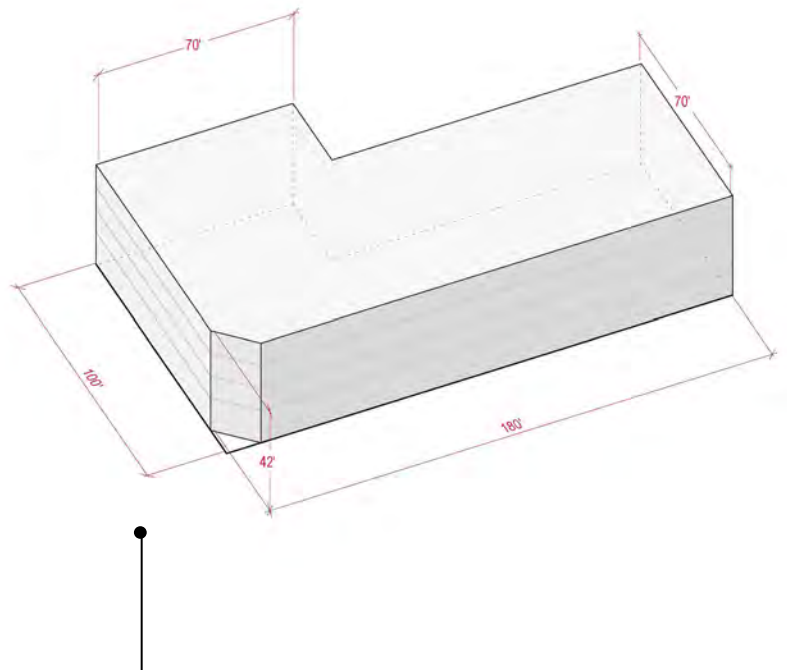

NC-40 Prototype – Existing

Lot size	18,000 sq. ft.
Total allowed gross area	58,500 sq. ft.
Efficiency factor	0.8
Ground-floor commercial	7,500 sq. ft.
Total net residential	40,800 sq. ft.
Total units	54
Average net unit size	755 sq. ft.
Parking spaces provided	underground

Affordable Homes

PERFORMANCE OPTION* (+ commercial addition)

High MHA area (7%)	4.48 (+ .33) = 5 units
Medium MHA area (6%)	3.84 (+ .33) = 5 units
Low MHA area (5%)	3.20 (+ .33) = 4 units

PAYMENT OPTION

High MHA area (\$20.75/sq. ft.)	\$1,245k (+ \$28k) = \$1,273,000
Med MHA area (\$13.25/sq. ft.)	\$795k (+ \$25k) = \$820,000
Low MHA area (\$7/sq. ft.)	\$420k (+ \$18k) = \$438,000

Proposed MHA NC-55

FAR maximum	3.75
Height limit	55 feet
Setbacks	
Front	First floor dwellings must be 4 feet above or 10 feet back from street
Upper	Avg. depth of 5 feet, max. depth of 15 feet above 45 feet
Rear	10 feet if next to residential zone
Sides	15 feet if next to residential zone
Façade modulation	Change of materials or a min. 18-inch-deep setback at a min. of every 50 feet
Parking	1 per unit; no minimum in urban villages

NC-55 Prototype – MHA

Lot size	18,000 sq. ft.
Total allowed gross area	67,500 sq. ft.
Efficiency factor	0.8
Ground-floor commercial	7,500 sq. ft.
Total net residential	48,000 sq. ft.
Total units	64
Average net unit size	750 sq. ft.
Parking spaces provided	underground

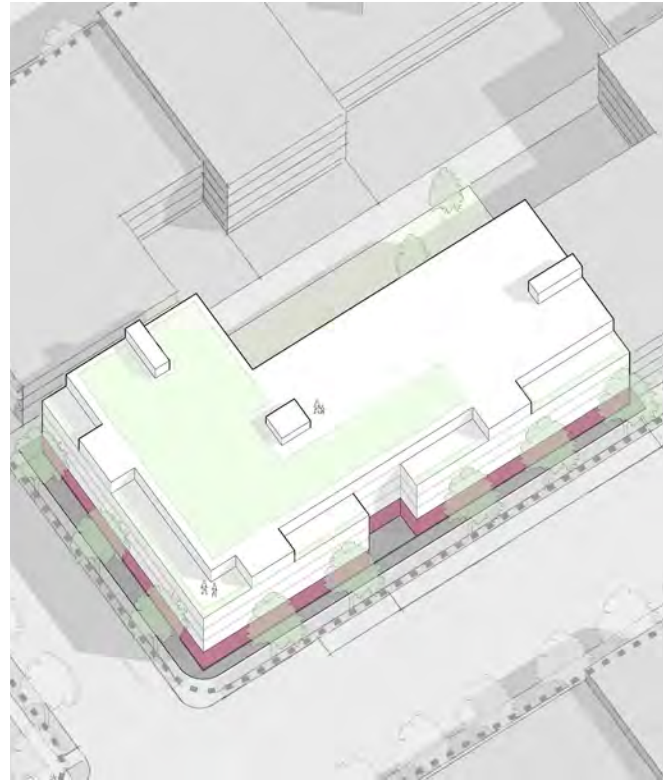

* If rounding down to provide affordable performance unit, developer must pay for the fraction they are rounding off as payment housing.

The first 4,000 sf of ground floor commercial does not count towards MHA requirements

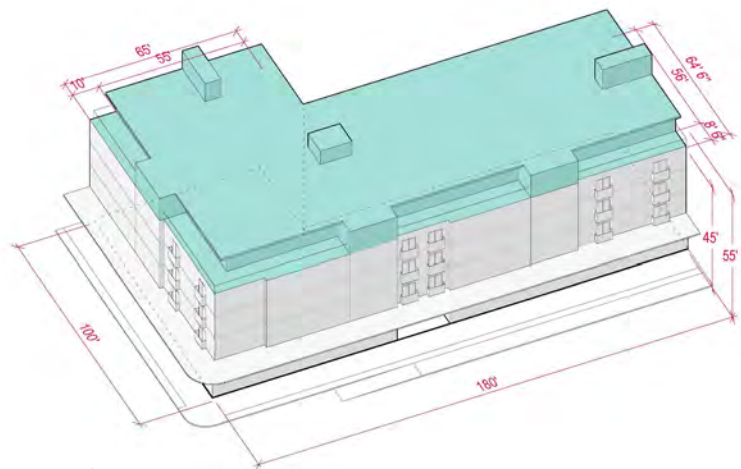

Neighborhood Commercial 75 mixed-use | typical lot size

Prototype Description

- An apartment or condominium housing product.
- Total lot size of 12,000 square feet.
- Underground parking is provided for some of the units.
- Considers adjacency to smaller Lowrise zones and similar or taller Midrise zones.
- Has street-level retail space.

Existing NC-65

FAR maximum	4.75
Height limit	65 feet
Setbacks	
Front	First floor dwellings must be 4 feet above or 10 feet back from street
Rear	10 feet if next to residential zone
Sides	15 feet if next to residential zone
Parking	1 per unit; no minimum in urban villages

NC-65 Prototype – Existing

Lot size	12,000 sq. ft.
Total allowed gross area	57,000 sq. ft.
Efficiency factor	0.8
Ground-floor commercial	10,000 sq. ft.
Total net residential	37,600 sq. ft.
Total units	65
Average net unit size	575 sq. ft.
Parking spaces provided	underground

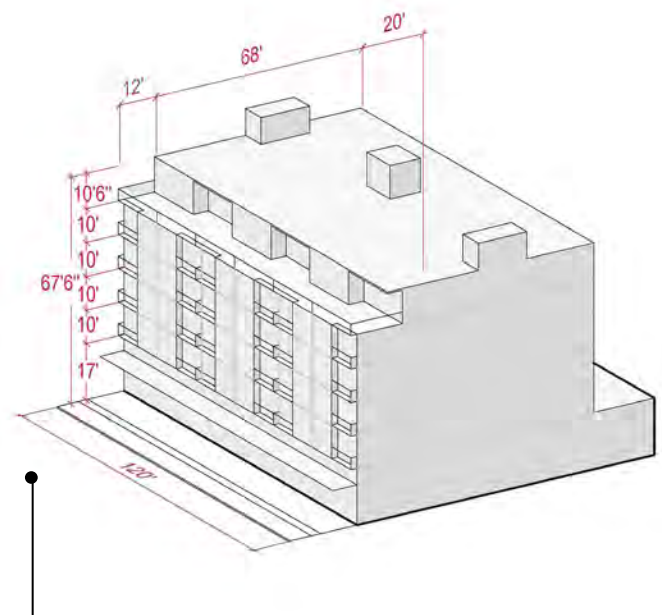

Affordable Homes

PERFORMANCE OPTION* (+ commercial addition)

High MHA area (7%)	5.46 (+ .52) = 6 units
Medium MHA area (6%)	4.68 (+ .52) = 6 units
Low MHA area (5%)	3.90 (+ .52) = 5 units

PAYMENT OPTION

High MHA area (\$20.75/sq. ft.)	\$1,162k (+ \$48k) = \$1,210,000
Med MHA area (\$13.25/sq. ft.)	\$742k (+ \$42k) = \$784,000
Low MHA area (\$7/sq. ft.)	\$392k (+ \$30k) = \$422,000

Proposed MHA NC-75

FAR maximum	5.5
Height limit	75 feet
Setbacks	
Front	First floor dwellings must be 4 feet above or 10 feet back from street
Upper	Avg. depth of 10 feet, max. depth of 20 feet above 55 feet
Rear	10 feet if next to residential zone
Sides	15 feet if next to residential zone
Façade modulation	Change of materials or a min. 18-inch-deep setback at a min. of every 50 feet
Parking	1 per unit; no minimum in urban villages

NC-75 Prototype – MHA

Lot size	12,000 sq. ft.
Total allowed gross area	66,000 sq. ft.
Efficiency factor	0.8
Ground-floor commercial	10,000 sq. ft.
Total net residential	44,800 sq. ft.
Total units	78
Average net unit size	575 sq. ft.
Parking spaces provided	underground

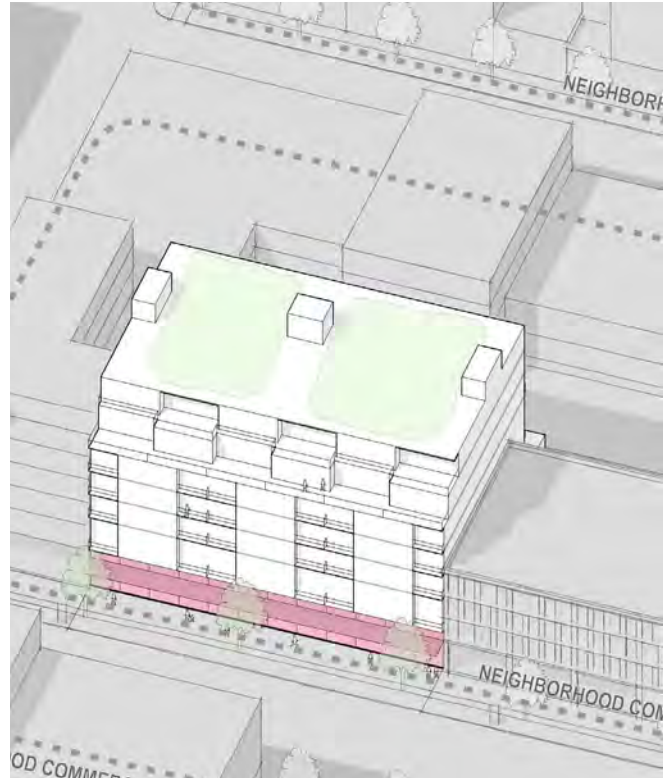

* If rounding down to provide affordable performance unit, developer must pay for the fraction they are rounding off as payment housing.

The first 4,000 sf of ground floor commercial does not count towards MHA requirements

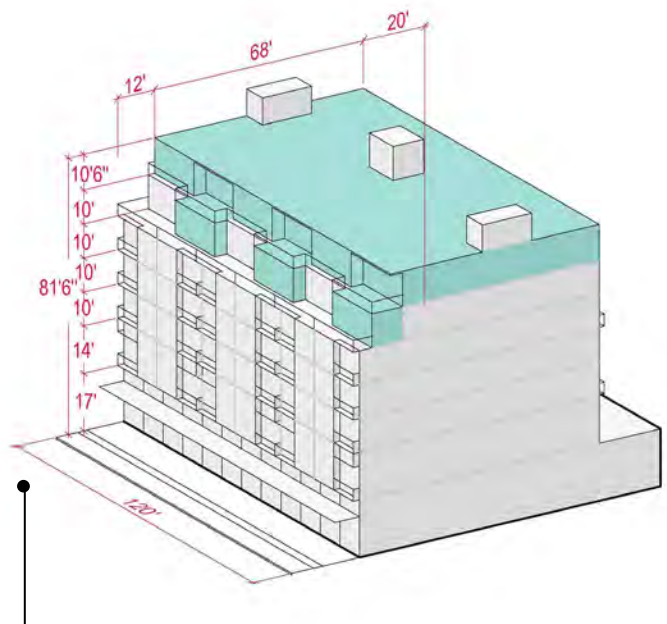

Neighborhood Commercial 75 mixed-use | large site

Prototype Description

- An apartment or condominium housing product.
- Total lot size of 46,000 square feet.
- Underground parking provided for some of the units.
- Considers adjacency to smaller Lowrise zones and similar or taller zones.
- Explores a large site redevelopment

Existing NC-65

FAR maximum	4.75
Height limit	65 feet
Setbacks	
Front	First floor dwellings must be 4 feet above or 10 feet back from street
Rear	10 feet if next to residential zone
Sides	15 feet if next to residential zone
Parking	1 per unit; no minimum in urban villages

NC-65 Prototype – Existing

Lot size	46,000 sq. ft.
Total allowed gross area	218,500 sq. ft.
Efficiency factor	0.8
Ground-floor commercial	40,000 sq. ft.
Total net residential	142,800 sq. ft.
Total units	201
Average net unit size	710 sq. ft.
Parking spaces provided	underground

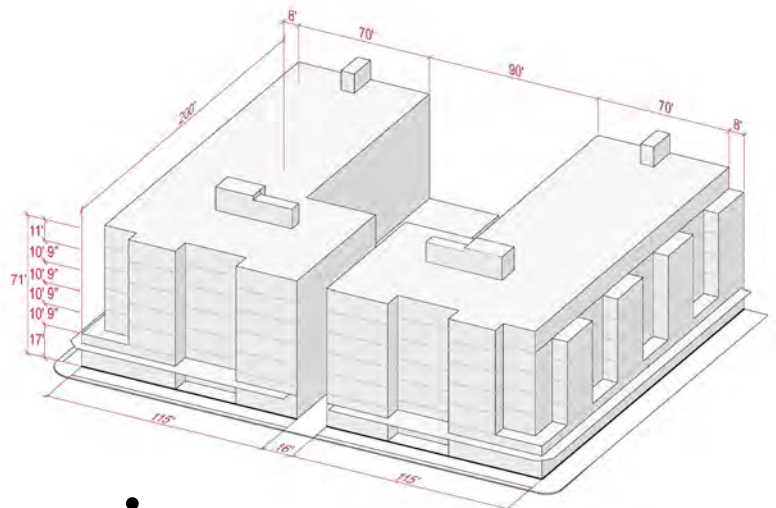

Affordable Homes

PERFORMANCE OPTION* (+ commercial addition)

High MHA area (7%)	16.80 (+ 2.54) = 20 units
Medium MHA area (6%)	14.40 (+ 2.54) = 17 units
Low MHA area (5%)	12.00 (+ 2.54) = 15 units

PAYMENT OPTION

High MHA area (\$20.75/sq. ft.)	\$4,420k (+ \$288k) = \$4,708k
Med MHA area (\$13.25/sq. ft.)	\$2,822k (+ \$252k) = \$3,074k
Low MHA area (\$7/sq. ft.)	\$1,491k (+ \$180k) = \$1,671k

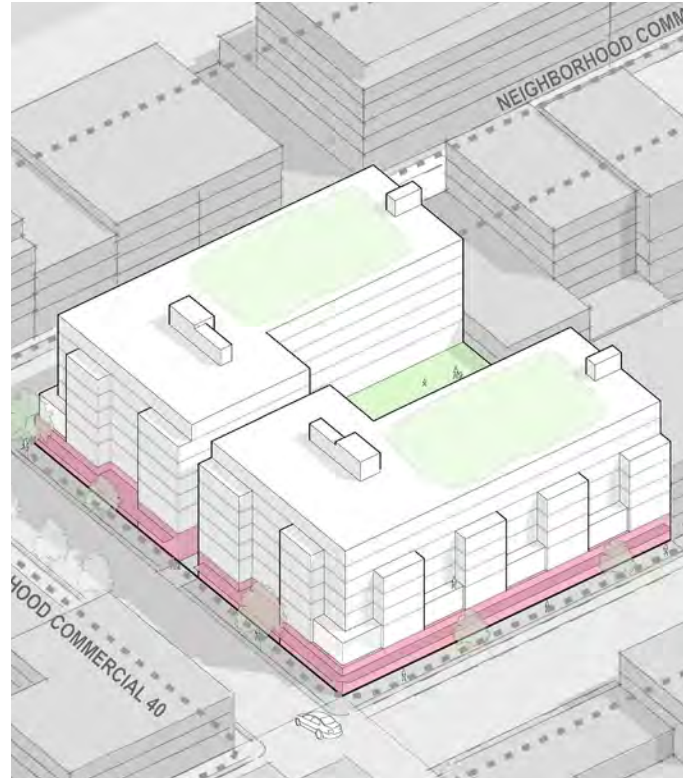

Proposed MHA NC-75

FAR maximum	5.5
Height limit	75 feet
Setbacks	
Front	First floor dwellings must be 4 feet above or 10 feet back from street
Upper	Avg. depth of 10 feet, max. depth of 20 feet above 55 feet
Rear	10 feet if next to residential zone
Sides	15 feet if next to residential zone
Façade modulation	Change of materials or a min. 18-inch-deep setback at a min. of every 50 feet
Parking	1 per unit; no minimum in urban villages

* If rounding down to provide affordable performance unit, developer must pay for the fraction they are rounding off as payment housing.

The first 4,000 sf of ground floor commercial does not count towards MHA requirements

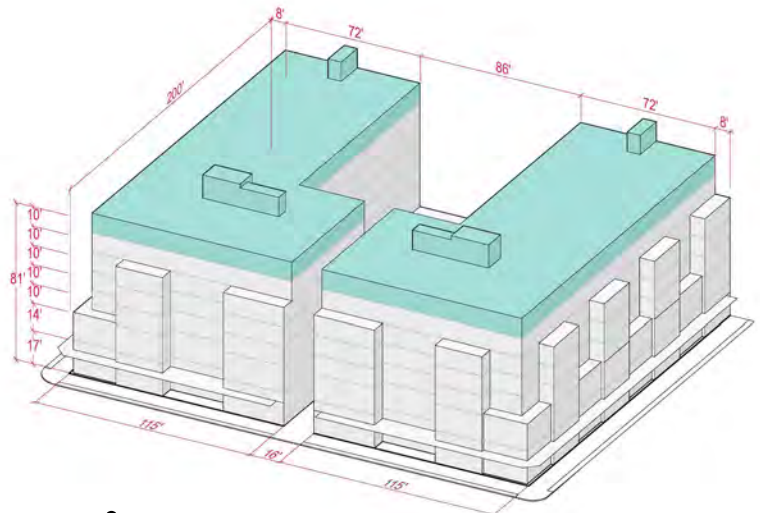

NC-75 Prototype – MHA

Lot size	46,000 sq. ft.
Total allowed gross area	253,000 sq. ft.
Efficiency factor	0.8
Ground-floor commercial	40,000 sq. ft.
Total net residential	170,400 sq. ft.
Total units	240
Average net unit size	710 sq. ft.
Parking spaces provided	underground

Neighborhood Commercial 95 mixed-use | 5-over-3 construction

Prototype Description

- An apartment or condominium housing product.
- Total lot size of 28,750 square feet.
- Underground parking provided for some of the units.
- Considers adjacency to smaller Lowrise zones and similar or taller Midrise zones.
- Reviews five stories of framed construction over three concrete levels.

Existing NC-85

FAR maximum	4.5 for single use 6.0 for mixed-use
Height limit	85 feet
Setbacks	
Front	First floor dwellings must be 4 feet above or 10 feet back from street
Rear	10 feet if next to residential zone
Sides	15 feet if next to residential zone
Parking	1 per unit; no minimum in urban villages

NC-85 Prototype – Existing

Lot size	28,750 sq. ft.
Total allowed gross area	172,500 sq. ft.
Efficiency factor	0.8
Ground-floor commercial	43,125 sq. ft.
Total net residential	103,500 sq. ft.
Total units	95 (18 live/work)
Average net unit size	1,056 sq. ft.
Parking spaces provided	underground

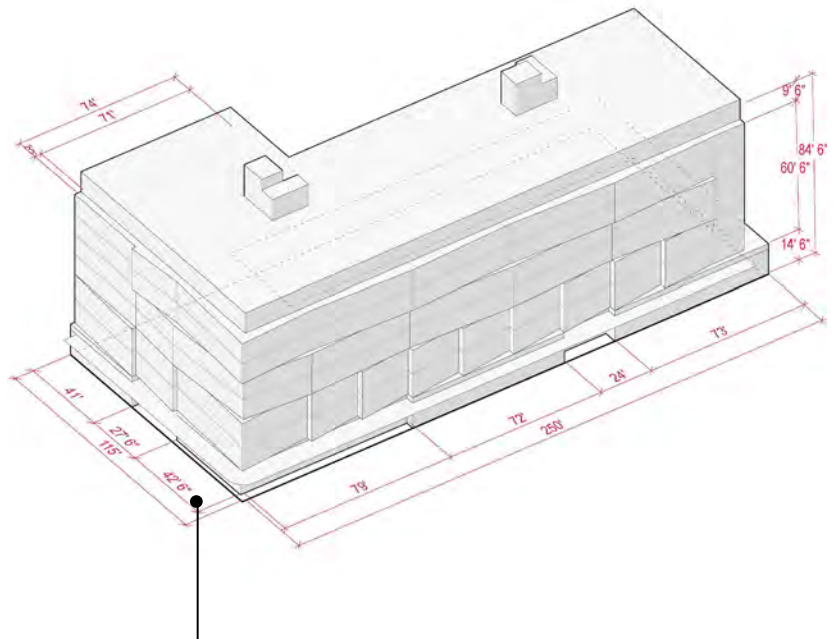

Affordable Homes

PERFORMANCE OPTION* (+ commercial addition)

High MHA area (7%)	7.56 (+ 1.93) = 10 units
Medium MHA area (6%)	6.48 (+ 1.93) = 9 units
Low MHA area (5%)	5.40 (+ 1.93) = 8 units

PAYMENT OPTION

High MHA area (\$20.75/sq. ft.)	\$2,834k (+ \$313k) = \$3,147k
Med MHA area (\$13.25/sq. ft.)	\$1,809k (+ \$274k) = \$2,083k
Low MHA area (\$7/sq. ft.)	\$956k (+ \$196k) = \$1,152k

Proposed MHA NC-95

FAR maximum	5.0 single use 6.25 mixed use
Height limit	95 feet
Setbacks	
Front	First floor dwellings must be 4 feet above or 10 feet back from street
Upper	Avg. depth of 15 feet, max. depth of 25 feet above 75 feet
Rear	10 feet if next to residential zone
Sides	15 feet if next to residential zone
Façade modulation	Change of materials or a min. 18-inch-deep setback at a min. of every 50 feet
Parking	1 per unit; no minimum in urban villages

NC-95 Prototype – MHA

Lot size	28,750 sq. ft.
Total allowed gross area	179,688 sq. ft.
Efficiency factor	0.8
Ground-floor commercial	43,125 sq. ft.
Total net residential	109,250 sq. ft.
Total units	108 (18 live/work)
Average net unit size	1,012 sq. ft.
Parking spaces provided	underground

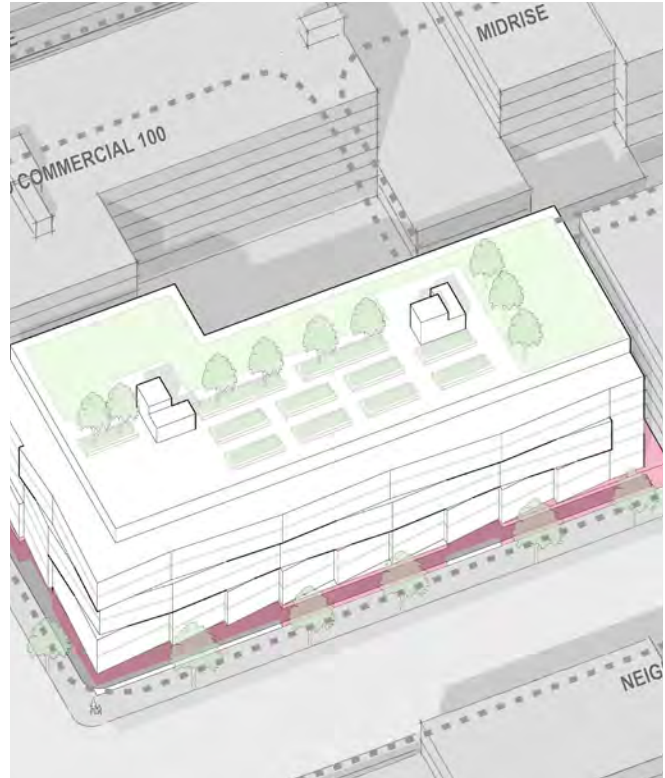

* If rounding down to provide affordable performance unit, developer must pay for the fraction they are rounding off as payment housing.

The first 4,000 sf of ground floor commercial does not count towards MHA requirements

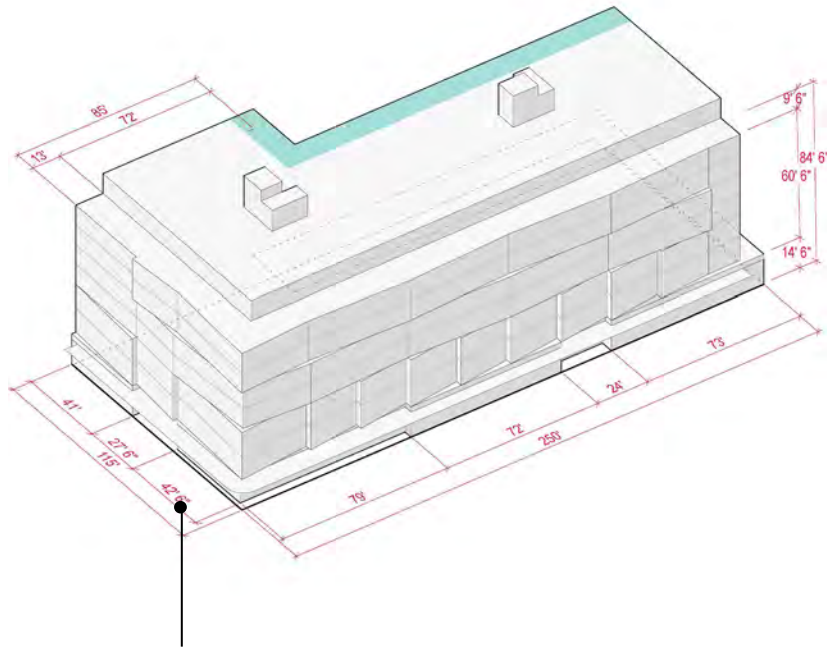

Neighborhood Commercial 95 mixed-use

9-story highrise construction

Prototype Description

- An apartment or condominium housing product.
- Total lot size of 28,750 square feet.
- Underground parking provided for some of the units.
- Considers adjacency to smaller Lowrise zones and similar or taller Midrise zones.
- Reviews highrise concrete or steel construction

Existing NC-85

FAR maximum	4.5 for single use 6.0 for mixed-use
Height limit	85 feet
Setbacks	
Front	First floor dwellings must be 4 feet above or 10 feet back from street
Rear	10 feet if next to residential zone
Sides	15 feet if next to residential zone
Parking	1 per unit; no minimum in urban villages

NC-85 Prototype – Existing

Lot size	28,750 sq. ft.
Total allowed gross area	172,500 sq. ft.
Efficiency factor	0.8
Ground-floor commercial	43,125 sq. ft.
Total net residential	103,500 sq. ft.
Total units	116 (10 live/work)
Average net unit size	819 sq. ft.
Parking spaces provided	underground

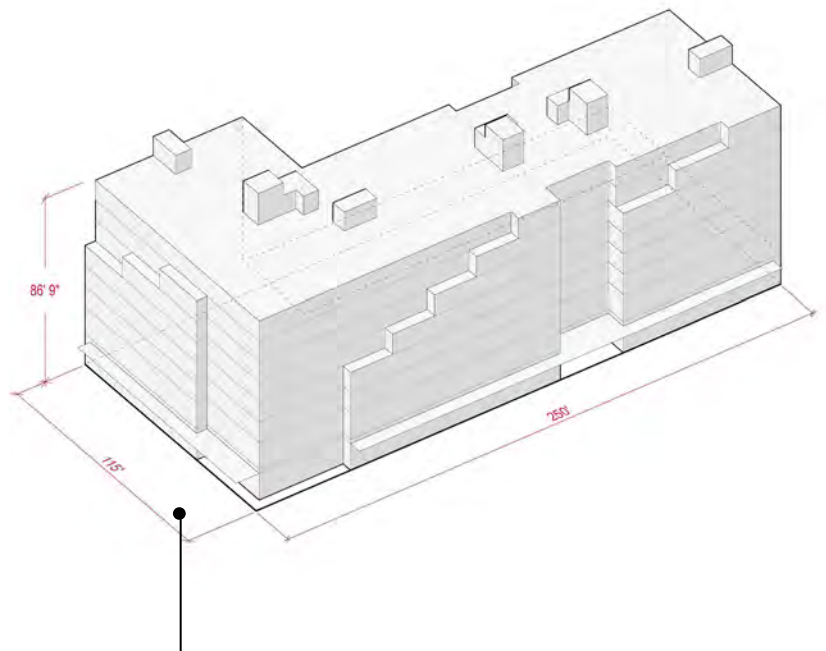

Affordable Homes

PERFORMANCE OPTION* (+ commercial addition)

High MHA area (7%)	8.82 (+ 3.45) = 13 units
Medium MHA area (6%)	7.56 (+ 3.45) = 12 units
Low MHA area (5%)	6.30 (+ 3.45) = 10 units

PAYMENT OPTION

High MHA area (\$20.75/sq. ft.)	\$2,536k (+ \$428k) = \$2,964k
Med MHA area (\$13.25/sq. ft.)	\$1,619k (+ \$375k) = \$1,994k
Low MHA area (\$7/sq. ft.)	\$855k (+ \$268k) = \$1,123k

Proposed MHA NC-95

FAR maximum	5.0 single use 6.25 mixed use
Height limit	95 feet
Setbacks	
Front	First floor dwellings must be 4 feet above or 10 feet back from street
Upper	Avg. depth of 15 feet, max. depth of 25 feet above 75 feet
Rear	10 feet if next to residential zone
Sides	15 feet if next to residential zone
Façade modulation	Change of materials or a min. 18-inch-deep setback at a min. of every 50 feet
Parking	1 per unit; no minimum in urban villages

NC-95 Prototype – MHA

Lot size	28,750 sq. ft.
Total allowed gross area	179,688 sq. ft.
Efficiency factor	0.8
Ground-floor commercial	57,500 sq. ft.
Total net residential	97,750 sq. ft.
Total units	126 (10 live/work)
Average net unit size	776 sq. ft.
Parking spaces provided	underground



* If rounding down to provide affordable performance unit, developer must pay for the fraction they are rounding off as payment housing.

The first 4,000 sf of ground floor commercial does not count towards MHA requirements

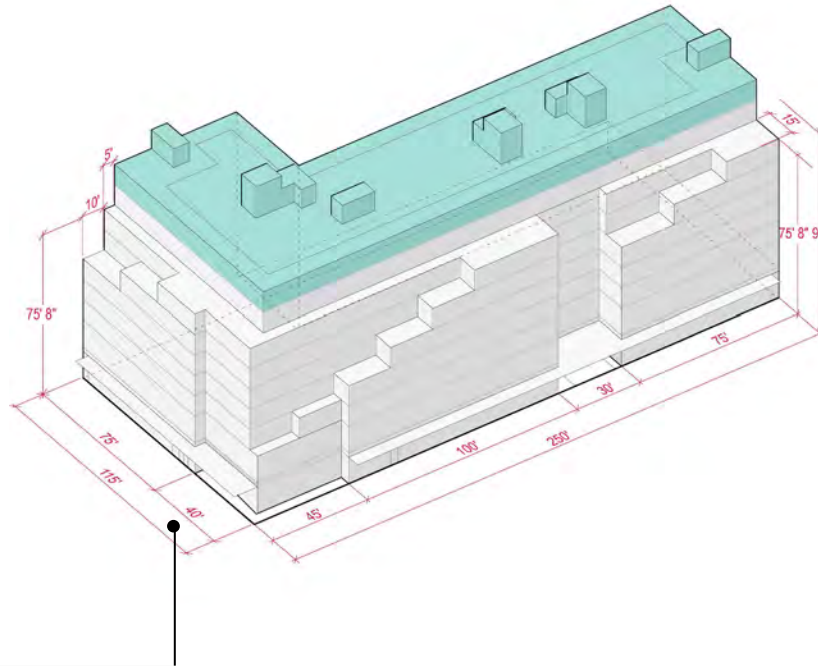

NC Zone - Urban Design and Neighborhood Character

Livability Benefits

- Street-facing upper-level setback standards are added, ensuring light and air access at the street level, and mitigating the impact of additional height.
- Minimum façade modulation requirements encourage varied building design and greater façade interest.
- A maximum building façade width is added to ensure human scale of buildings.
- In some zones, the additional allowed height will result in more varied and modulated building masses and forms (e.g., NC-40 and NC-55 zones).
- An option for a highrise building form in the NC-95 zone would result in more livable units with higher ceiling-to-ceiling heights and larger windows.



Minimum façade modulation requirements are added to encourage varied building design and greater façade interest as illustrated in the NC-95 zone.

Buildings in the NC-95 zone with higher ceiling-to-ceiling heights and larger windows allow improved daylight conditions in units.

Overall this configuration enjoys livability benefits of high rise construction. The building massing is more slender and provides more modulation than a non high-rise construction in the same zone.

HALA DAYLIGHT STUDY

E Level 2
Wall Height: 12'-0"

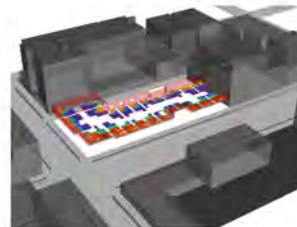
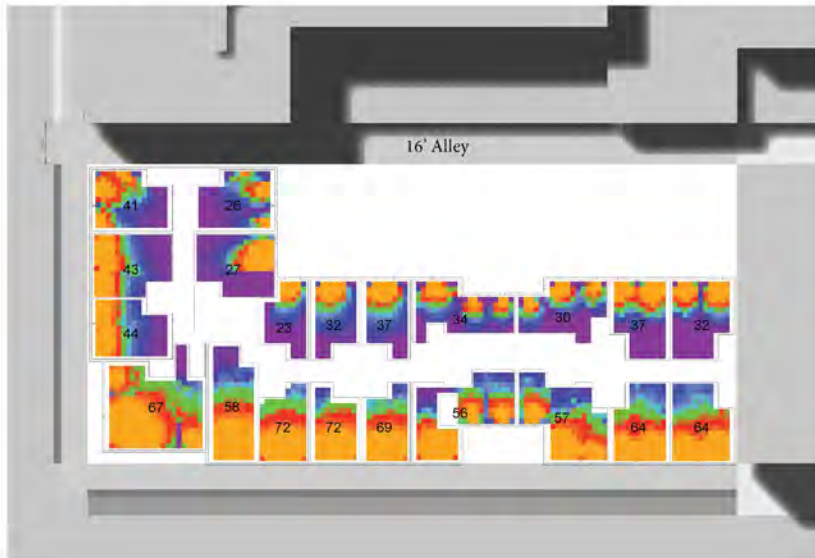

Study Assumptions:
Windows are located in every habitable room. Window area is calculated at the code minimum of 8% of the habitable floor area

0% 100%
Daylight Autonomy:
Percent of annual hours 8:00am - 6:00pm that exceeds 100 lux at 30" AFF

HALA DAYLIGHT STUDY

E Level 4
Wall Height: 9'-0"

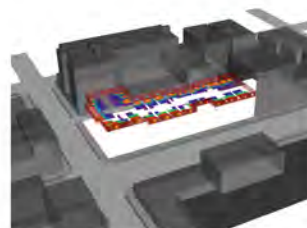
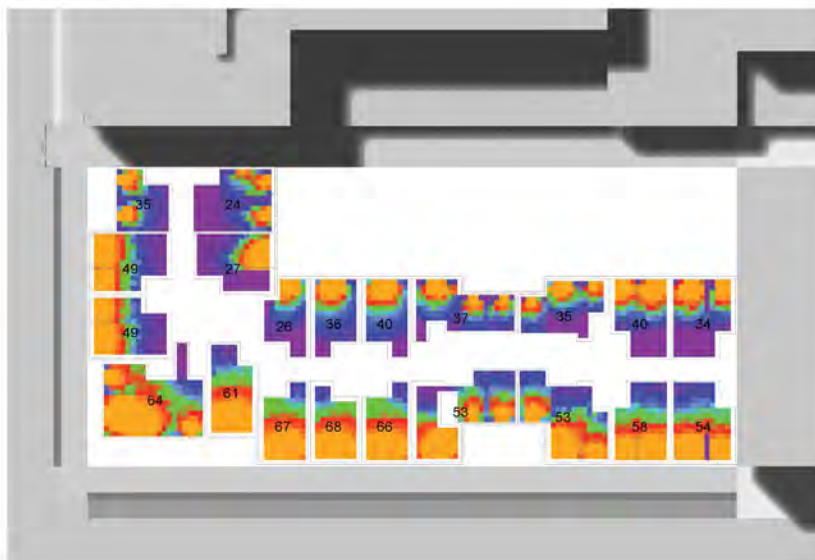

Study Assumptions:
Windows are located in every habitable room. Window area is calculated at the code minimum of 8% of the habitable floor area

0% 100%
Daylight Autonomy:
Percent of annual hours 8:00am - 6:00pm that exceeds 100 lux at 30" AFF



Proposed standards for the NC-40 zone supports a day care center among other amenities. FAR maximums relative to height limits support more open space in NC zones.



Neighborhood Commercial storefronts enhance the pedestrian experience.

Proposed Development and Urban Design Standards

The table below summarizes other proposed or modified development standards intended to improve an urban design outcome and improve livability with new development in the zone.

Issue / Intent	Lowrise Zone	Proposed / Modified Development Standard
Increase design flexibility and provide opportunity for increased housing production. Discourage production of ineffective street level retail space.	NC-40 NC-55 NC-75	<ul style="list-style-type: none"> Remove the use-based maximum FAR limits, so a single total maximum allowed FAR is provided.
Ensure light and air access to public rights of way, and compatibility of street facing building scale, as height limits are increased.	NC-55 NC-75 NC-95	<ul style="list-style-type: none"> In the NC-55 zone add a 5' average depth upper level setback at a height of 45'. the maximum setback depth is 15' for purposes of setback calculation. In the NC-75 zone add a 10' average depth upper level setback at a height of 55'. The maximum setback depth is 20' for purposes of setback calculation. In the NC-95 zone add a 15' average depth upper level setback at a height of 75'. The maximum setback depth is 25' for purposes of setback calculation.
Encourage human scaled buildings, and compatibility of infill development with context.	NC-75 NC-95	<ul style="list-style-type: none"> Require a break in building massing or pass-through, by adding a maximum building width standard of 240'.
Encourage design interest and human scale in large scale building facades.	NC-55 NC-75 NC-95	<ul style="list-style-type: none"> Provide facade modulation with minimum depth of 18", or change in material, texture, or color, at every 50' of facade width.
Encourage effective street level retail spaces	NC-30 NC-40	<ul style="list-style-type: none"> Retain an additional 4' height allowance for buildings that provide tall ground floor commercial spaces of at least 13'.

Midrise (MR)

Community Input

In general, the height limit and floor area increases are incremental and a good tradeoff for the affordable housing requirement.

- Incorporate open spaces and courtyards where possible.
- Consider the Midrise zone in more locations that are very close to frequent transit hubs.
- Encourage a variety of housing sizes.

Zoning Prototypes

The following pages discuss the three apartment prototypes in the Midrise zone on small and large sites.



Apartments
small site
additional height



Apartments
small site
additional depth



Apartments
large site

Location of existing Midrise zones

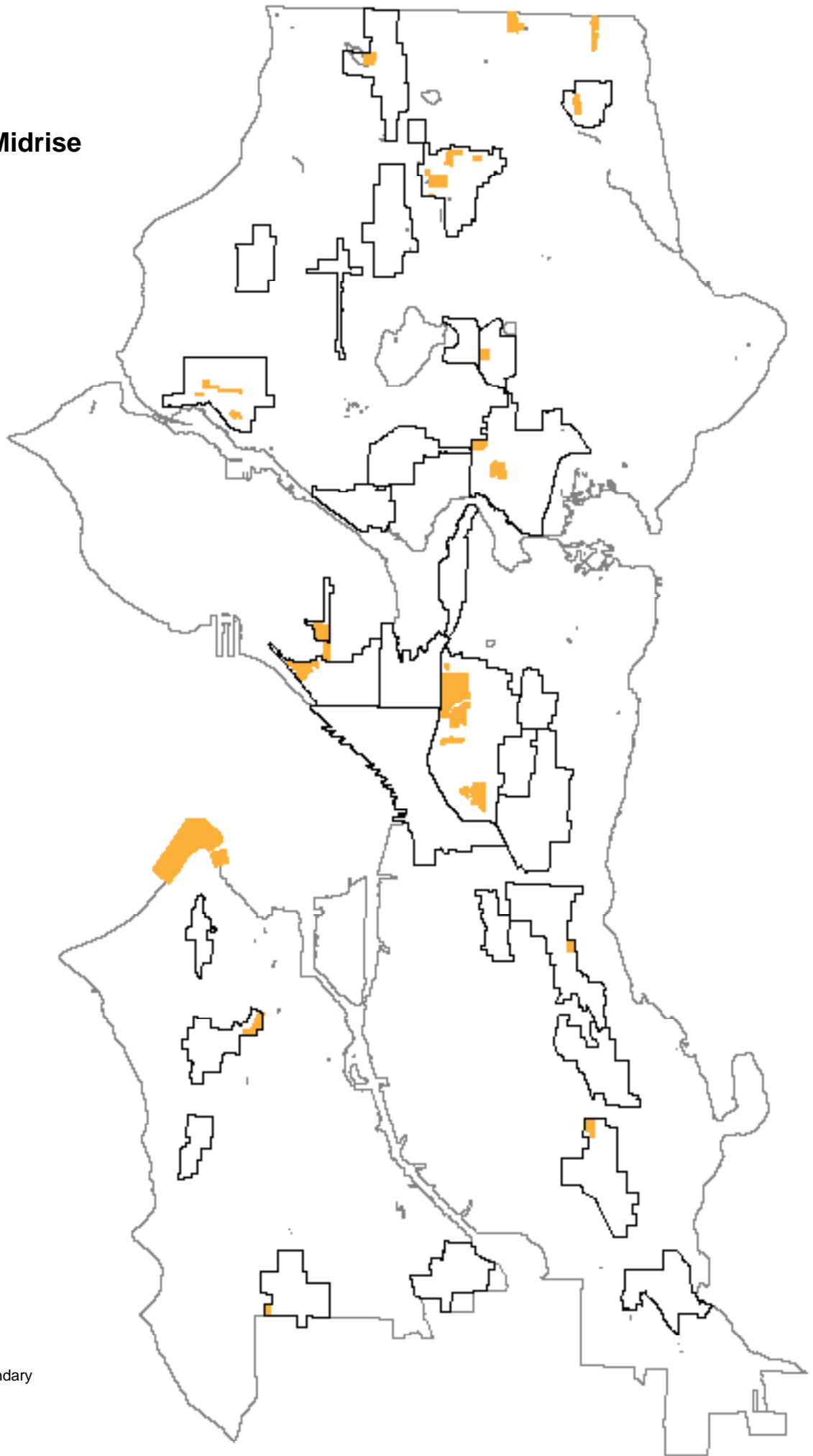

Urban Village Boundary
Existing MR

MIDRISE

rental apartments | additional depth

Prototype Description

- An apartment or condominium housing product.
- Total lot size of 10,000 square feet.
- Underground parking is provided for some of the units.
- Considers adjacency to smaller Lowrise zones and similar or smaller Neighborhood Commercial zones.
- Additional floor area is achieved by greater building depth in a 7-story product.

Existing MR

FAR maximum	3.2 base 4.25 bonus
Height limit	60 feet base 75 feet bonus
Setbacks	
Front	5 feet minimum 0 feet if courtyard
Rear	10 feet with alley 15 feet without alley
Sides	<42 ft.: 5 ft. min/7 ft. avg >42ft.: 7 ft. min
Max. depth	75% of lot depth
Parking	1 per unit; no minimum in urban villages

MR Prototype – Existing

Lot size	10,000 sq. ft.
Total allowed gross area	42,500 sq. ft.
Efficiency factor	0.8
Total net sq. ft.	34,000 sq. ft.
Total units	56
Average net unit size	607 sq. ft.
Parking spaces provided	underground

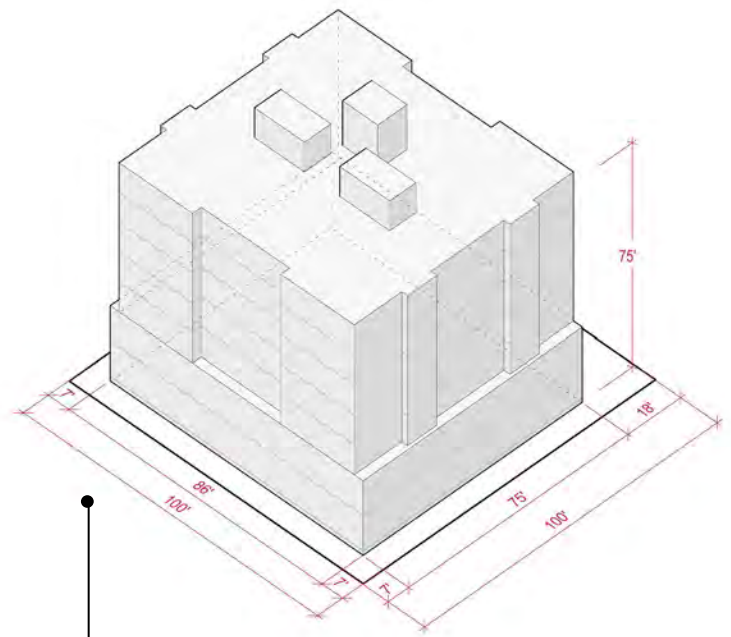

Affordable Homes

PERFORMANCE OPTION*

High MHA area (7%)	4.90 = 5 units
Medium MHA area (6%)	4.20 = 5 units
Low MHA area (5%)	3.50 = 4 units

PAYMENT OPTION

High MHA area (\$20.75/sq. ft.)	\$934,000
Med MHA area (\$13.25/sq. ft.)	\$596,000
Low MHA area (\$7/sq. ft.)	\$315,000

* If rounding down to provide affordable performance unit, developer must pay for the fraction they are rounding off as payment housing.

Proposed MHA MR

FAR maximum	4.5
Height limit	80 feet
Setbacks	
Front	5 feet minimum 0 feet if courtyard
Upper	Above 70 feet: 15 feet (front and rear) 5 feet (sides)
Rear	10 feet with alley 15 feet without alley
Sides	<42 ft.: 5 ft. min/7 ft. avg >42ft.: 7 ft. min
Max. depth	80% of lot depth
Parking	1 per unit; no minimum in urban villages

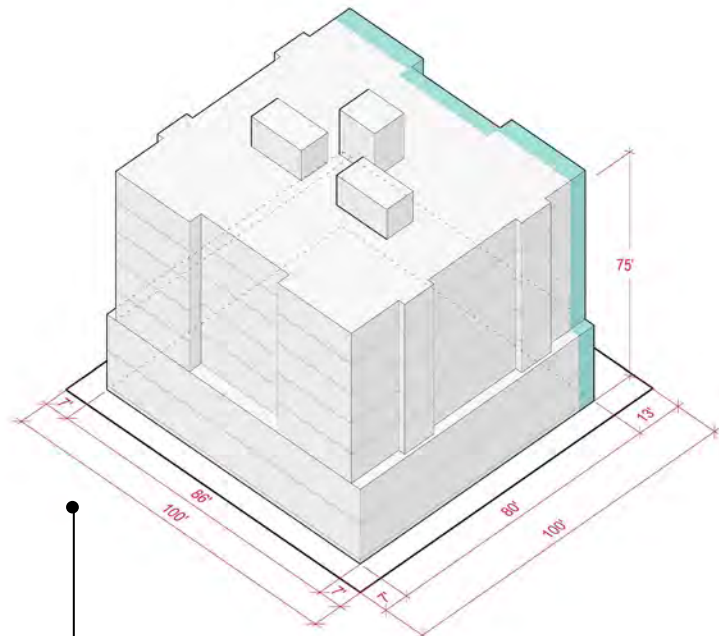

MR Prototype – Proposed

Lot size	10,000 sq. ft.
Total allowed gross area	45,000 sq. ft.
Efficiency factor	0.8
Total net sq. ft.	36,000 sq. ft.
Total units	70
Average net unit size	514 sq. ft.
Parking spaces provided	underground

MIDRISE

rental apartments | additional height

Prototype Description

- An apartment or condominium housing product.
- Total lot size of 10,000 square feet.
- Underground parking is provided for some of the units.
- Considers adjacency to smaller Lowrise zones and similar or smaller Neighborhood Commercial zones.
- Greater building variation is achieved by greater building height in a 8-story product.

Existing MR

FAR maximum	3.2 base 4.25 bonus
Height limit	60 feet base 75 feet bonus
Setbacks	
Front	5 feet minimum 0 feet if courtyard
Rear	10 feet with alley 15 feet without alley
Sides	<42 ft.: 5 ft. min/7 ft. avg >42ft.: 7 ft. min
Max. depth	75% of lot depth
Parking	1 per unit; no minimum in urban villages

MR Prototype – Existing

Lot size	10,000 sq. ft.
Total allowed gross area	42,500 sq. ft.
Efficiency factor	0.8
Total net sq. ft.	34,000 sq. ft.
Total units	56
Average net unit size	607 sq. ft.
Parking spaces provided	underground

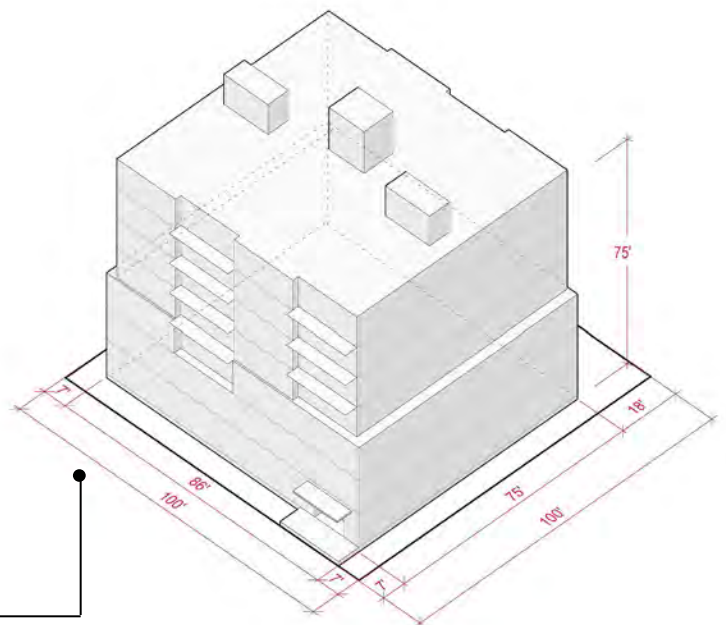

Affordable Homes

PERFORMANCE OPTION*

High MHA area (7%)	4.20 = 5 units
Medium MHA area (6%)	3.60 = 5 units
Low MHA area (5%)	3.00 = 3 units

PAYMENT OPTION

High MHA area (\$ 20.75/sq. ft.)	\$934,000
Med MHA area (\$13.25/sq. ft.)	\$596,000
Low MHA area (\$7/sq. ft.)	\$315,000

* If rounding down to provide affordable performance unit, developer must pay for the fraction they are rounding off as payment housing.

Proposed MHA MR

FAR maximum	4.5
Height limit	80 feet
Setbacks	
Front	5 feet minimum 0 feet if courtyard
Upper	Above 70 feet: 15 feet (front and rear) 5 feet (sides)
Rear	10 feet with alley 15 feet without alley
Sides	<42 ft.: 5 ft. min/7 ft. avg >42ft.: 7 ft. min
Max. depth	80% of lot depth
Parking	1 per unit; no minimum in urban villages

MR Prototype – Proposed

Lot size	10,000 sq. ft.
Total allowed gross area	45,000 sq. ft.
Efficiency factor	0.8
Total net sq. ft.	36,000 sq. ft.
Total units	60
Average net unit size	600 sq. ft.
Parking spaces provided	underground

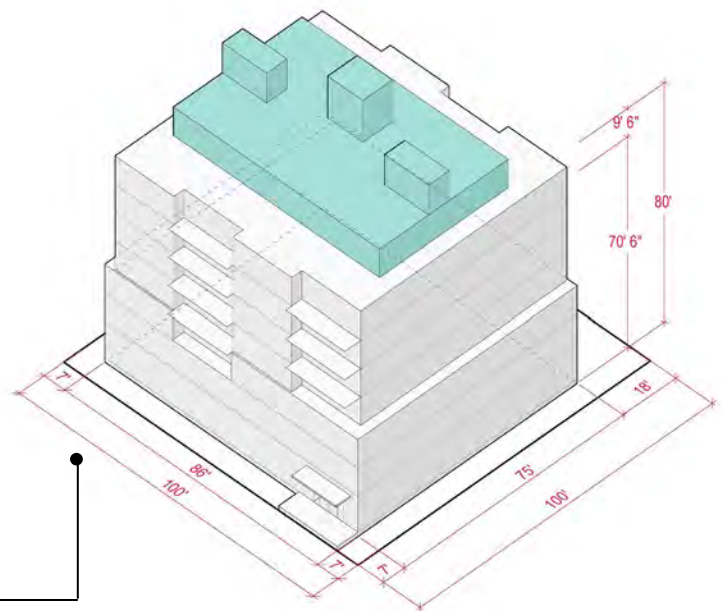

MIDRISE

rental apartments | large infill site

Prototype Description

- An apartment or condominium housing product.
- Total lot size of 20,000 square feet.
- Underground parking is provided for some of the units.
- Considers adjacency to smaller Lowrise zones and similar or smaller Neighborhood Commercial zones.
- Explores a courtyard condition

Existing Midrise

FAR maximum	3.2 base 4.25 bonus
Height limit	60 feet base 75 feet bonus
Setbacks	
Front	5 feet minimum 0 feet if courtyard
Rear	10 feet with alley 15 feet without alley
Sides	<42 ft.: 5 ft. min/7 ft. avg >42ft.: 7 ft. min
Max. depth	75% of lot depth
Parking	1 per unit; no minimum in urban villages

Midrise Prototype –

Lot size	20,000 sq. ft.
Total allowed gross area	85,000 sq. ft.
Efficiency factor	0.8
Total net sq. ft.	68,000 sq. ft.
Area below grade	5,000 sq. ft.
Total units	122
Average net unit size	598 sq. ft.
Parking spaces provided	underground

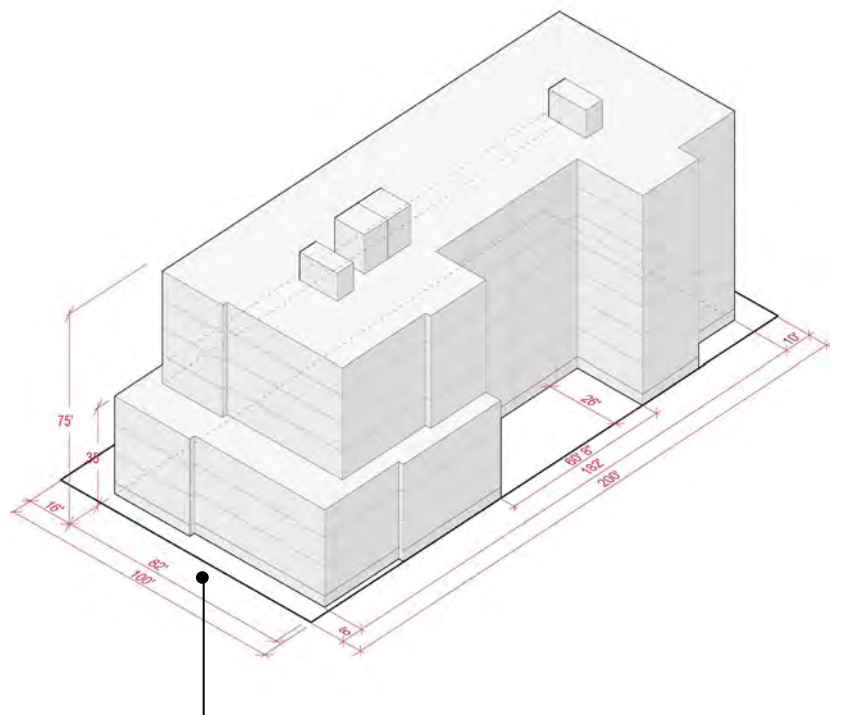

Affordable Homes

PERFORMANCE OPTION*

High MHA area (7%)	8.82 = 9 units
Medium MHA area (6%)	7.56 = 8 units
Low MHA area (5%)	6.30 = 7 units

PAYMENT OPTION

High MHA area (\$20.75/sq. ft.)	\$1,971,000
Med MHA area (\$13.25/sq. ft.)	\$1,259,000
Low MHA area (\$7/sq. ft.)	\$665,000

* If rounding down to provide affordable performance unit, developer must pay for the fraction they are rounding off as payment housing.

Proposed MHA

FAR maximum	4.5
Height limit	80 feet
Setbacks	
Front	5 feet minimum 0 feet if courtyard
Upper	Above 70 feet: 15 feet (front and rear) 5 feet (sides)
Rear	10 feet with alley 15 feet without alley
Sides	<42 ft.: 5 ft. min/7 ft. avg >42ft.: 7 ft. min
Max. depth	80% of lot depth
Parking	1 per unit; no minimum in urban villages

Midrise Prototype – MHA

Lot size	20,000 sq. ft.
Total allowed gross area	90,000 sq. ft.
Efficiency factor	0.8
Total net sq. ft.	72,000 sq. ft.
Total units	126
Average net unit size	611 sq. ft.
Parking spaces provided	underground

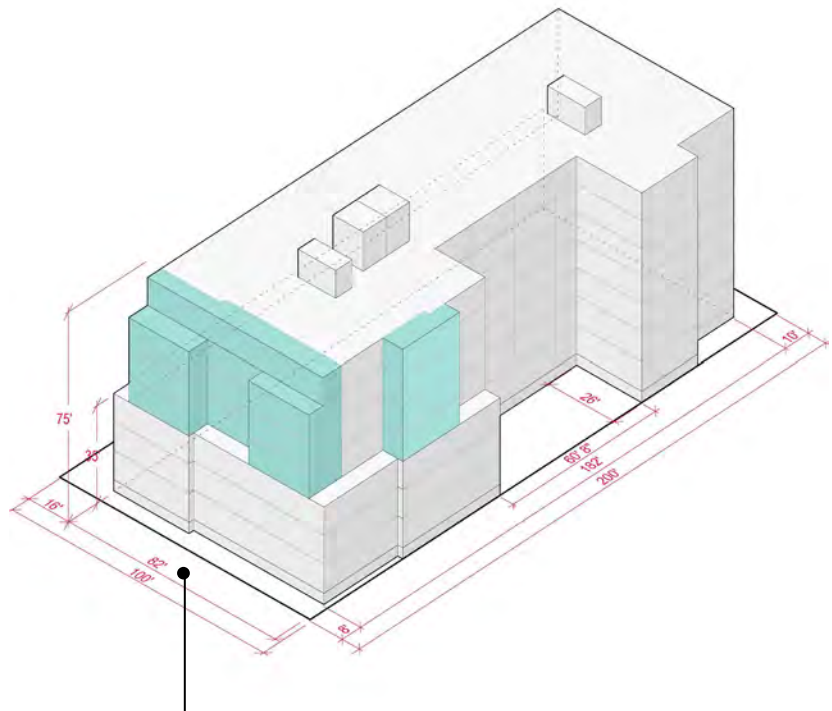

MR Zone - Urban Design and Neighborhood Character

Livability Benefits

- Midrise zones provide for infill housing opportunities in locations with the best access to transit and services.
- Courtyard design and open space standards provide amenities for residents of the housing units.

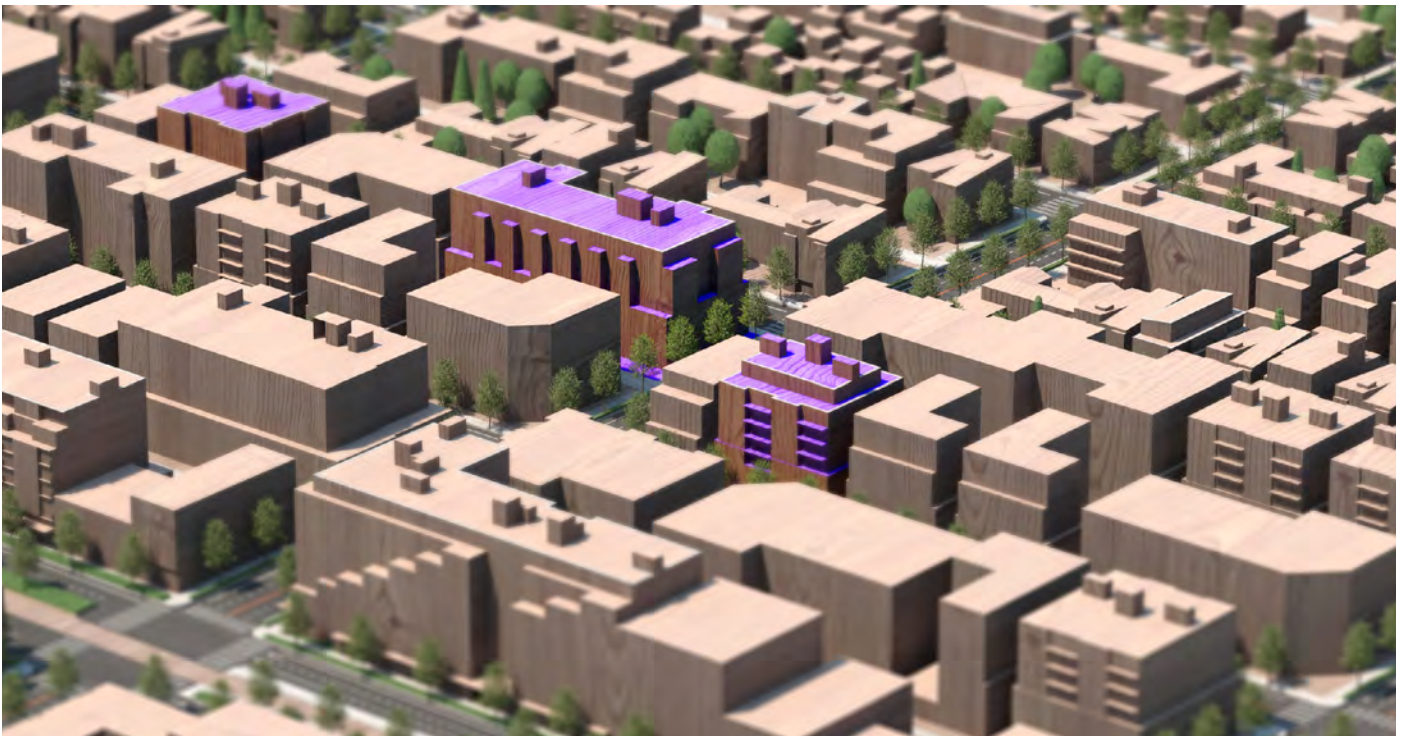

As one of the most densest residential prototypes, Midrise zones have development standards requiring separation in the building mass to reduce the overall bulk of structures.

Proposed Development and Urban Design Standards

Issue	Proposed / Modified Development Standard
Increase design flexibility and provide opportunity for increased housing production.	<ul style="list-style-type: none"> To allow flexibility to achieve more housing, the maximum lot depth limit increases from 75% to 80% and the maximum height limit increases from 75' to 80' to allow variation in building form
Provide usable open space amenities for residents.	<ul style="list-style-type: none"> Standards for a courtyard housing option are retained.
Ensure light and air access to public rights of way, and compatibility of street facing building scale, as height limits are increased.	<ul style="list-style-type: none"> A new upper-level setback standard reduces the impact of the additional story on access to light at street level and in open spaces.



MHA would retain standards for a courtyard housing option.

Other Zones

Limited Application outside of Downtown and South Lake Union

Several zones outside of Downtown and South Lake Union apply only in limited locations. These zones primarily allow highrise development, uncommon today in most of the study locations. We aren't proposing to expand where highrise development can occur as part of MHA. A few of these zones with limited locations outside of Downtown and South Lake Union are areas that have undergone a recent specific planning effort, such as the blocks around the Mt Baker Light Rail station.

Additional modeling and analysis of development capacity increases in these zones will be provided. The table below summarizes the draft proposed development capacity for the zones not included in the prototypes above.



No new highrise zones are proposed as part of MHA.

Existing Zone	Proposed Zone	Existing Development Standard	Proposed Capacity Increase
Highrise (HR)	Highrise (HR)	<ul style="list-style-type: none"> Maximum FAR (with bonuses) for buildings 240' and less: 13 Maximum FAR (with bonuses) for buildings over 240': 14 Maximum Height: 300 feet 	<ul style="list-style-type: none"> Maximum FAR (with bonuses) buildings 240' and less: 14 Maximum FAR (with bonuses) buildings over 240': 15 Maximum Height: 340 feet
NC-125	NC-145	<ul style="list-style-type: none"> Maximum FAR single use: 5 Maximum FAR all uses: 6 Height Limit: 125 feet 	<ul style="list-style-type: none"> Maximum FAR single use: 6 Maximum FAR all uses: 7 Height Limit: 145 feet
NC-160	NC-200	<ul style="list-style-type: none"> Maximum FAR single use: 5 Maximum FAR all uses: 7 Height limit: 160 feet 	<ul style="list-style-type: none"> Maximum FAR single use: 6.5 Maximum FAR all uses: 8.25 Height limit: 200 feet
All Industrial Commercial Zones (IC)	IC	<ul style="list-style-type: none"> Maximum FAR: 2.5 	<ul style="list-style-type: none"> Maximum FAR: 2.75

Seattle Mixed - North Rainier Zones (SM-NR)

SM-NR 65	SM-NR 75	<ul style="list-style-type: none"> Maximum FAR (with bonus): 5.0 Height Limit: 65 feet 	<ul style="list-style-type: none"> Maximum FAR: 5.25 Height Limit: 75 feet
SM-NR 55/75	SM-NR 55/85	<ul style="list-style-type: none"> Maximum FAR (with bonus): no limit Residential Height Limit (with bonus): 75 feet 	<ul style="list-style-type: none"> Maximum FAR: no limit Residential Height Limit: 85 feet
SM-NR 85	SM-NR 95	<ul style="list-style-type: none"> Maximum FAR (with bonus): 6.0 Height Limit: 85 feet 	<ul style="list-style-type: none"> Maximum FAR: 6.25 Height Limit: 95 feet
SM-NR 125	SM-NR 145	<ul style="list-style-type: none"> Maximum FAR (with bonus): 8.0 Height Limit: 125 feet 	<ul style="list-style-type: none"> Maximum FAR: 8.25 Height Limit: 145 feet

Seattle Mixed Dravus Zone (SM-D)

This zone does not have maximum FAR controls. The height limit and other dimensional standards govern the amount of development that can occur on a lot.

SM-D 40-85	SM-D 95	<ul style="list-style-type: none"> Maximum height (with bonus): 85 feet 	<ul style="list-style-type: none"> Maximum height: 95 feet
------------	---------	--	---

Overlay Zones

Addressing Overlay Zones

An overlay zone designation applies as a layer in addition to a base zoning designation. Overlay zones address conditions unique to an area or set of issues. Examples include Station Area Overlay Zones near light rail stations, or the Stadium Transition Area Overlay District near by the professional sports stadiums.

Since some overlay zones modify base developments standards such as the FAR limit, it is necessary to consider how increases in development capacity to implement MHA would be applied to overlay zones. Additional modeling and analysis of development capacity increases in overlay zones will be provided. The table at right summarizes the draft proposed development capacity increases for overlay zones.

FAR Requirements in the Station Area Overlay District

	Existing FAR	Proposed MHA FAR
NC-40 (Currently NC-30)	3	3.25 ¹
NC-55 (Currently NC-40)	4	4.25 ¹
NC-75 (Currently NC-65)	5.75	6 ¹
NC-95 (Currently NC-85)	6	6.25 ¹
NC-145 (Currently NC-125)	6	7
NC-200 (Currently NC-160)	7	8.25

¹ In these zones, existing development capacity is generally limited by height rather than FAR so additional development capacity is primarily provided through additional height.

Name	Description	Proposal
Shoreline District	The Shoreline District applies to properties within 200 feet of the shorelines of Puget Sound, Lake Washington, and the Duwamish River. Properties in this district are generally subject to additional restrictions on height and building location under state and local regulations.	Most properties within the shoreline district would not receive additional development capacity and will be exempt from MHA due to the constraints of Shoreline District regulations and the City's policy to limit development adjacent to environmentally sensitive areas. However, properties that are within the shoreline district but are separated from the shoreline by a street or other right-of-way will receive additional capacity and be subject to MHA.
Historic Districts	The City has eight designated historic districts. Development in these areas is subject to additional review and requirements.	City-designated historic districts would not receive additional development capacity and will be exempt from MHA.
Pike/Pine	Properties in this area can achieve one additional floor of residential development if they meet certain requirements to retain existing buildings or to provide spaces for small businesses and arts facilities. Properties may also sell development rights to preserve existing character buildings.	This area would receive additional development capacity and be subject to MHA. Properties would continue to be able to achieve one extra floor above the height limit through the incentive program.
Major Institution Overlay Districts	These districts are areas where a major institution, such as a large hospital or university, has developed a major institution master plan. These plans must be approved by City Council, but provide tailored development standards that account for the unique needs and plans of the institution.	These areas would receive additional development capacity and be subject to MHA. Institutional uses are not subject to MHA, but commercial and residential development in these areas would contribute to affordable housing. Major Institutional Master Plans that allow additional development beyond the underlying zoning would not be changed.
Stadium Transition Area Overlay District	Development in this district is subject to additional requirements for parking and design, but is also subject to a higher floor area ratio.	Development in this district would receive the same amount of additional capacity as similar zones outside the district.
Station Area Overlay Districts	Development in this district is subject to additional land use and design requirements, but is also subject to a higher floor area ratio.	Development in this district would receive additional development capacity as shown in the table following this chart.
Northgate Overlay District	The purpose of the Northgate Overlay District is to: Create an environment that is more amenable to pedestrians and supportive of commercial development; protect the residential character of residential neighborhoods; and support Northgate as a regional high-capacity transportation center.	The area will receive additional development capacity through the capacity increase to the underlying MHA zones. Design and development standards specific to Northgate including: street level uses, parking location and screening etc. will be retained. Development standards at SMC 23.71.040 that limit housing production with Northgate Specific density limits will be removed.

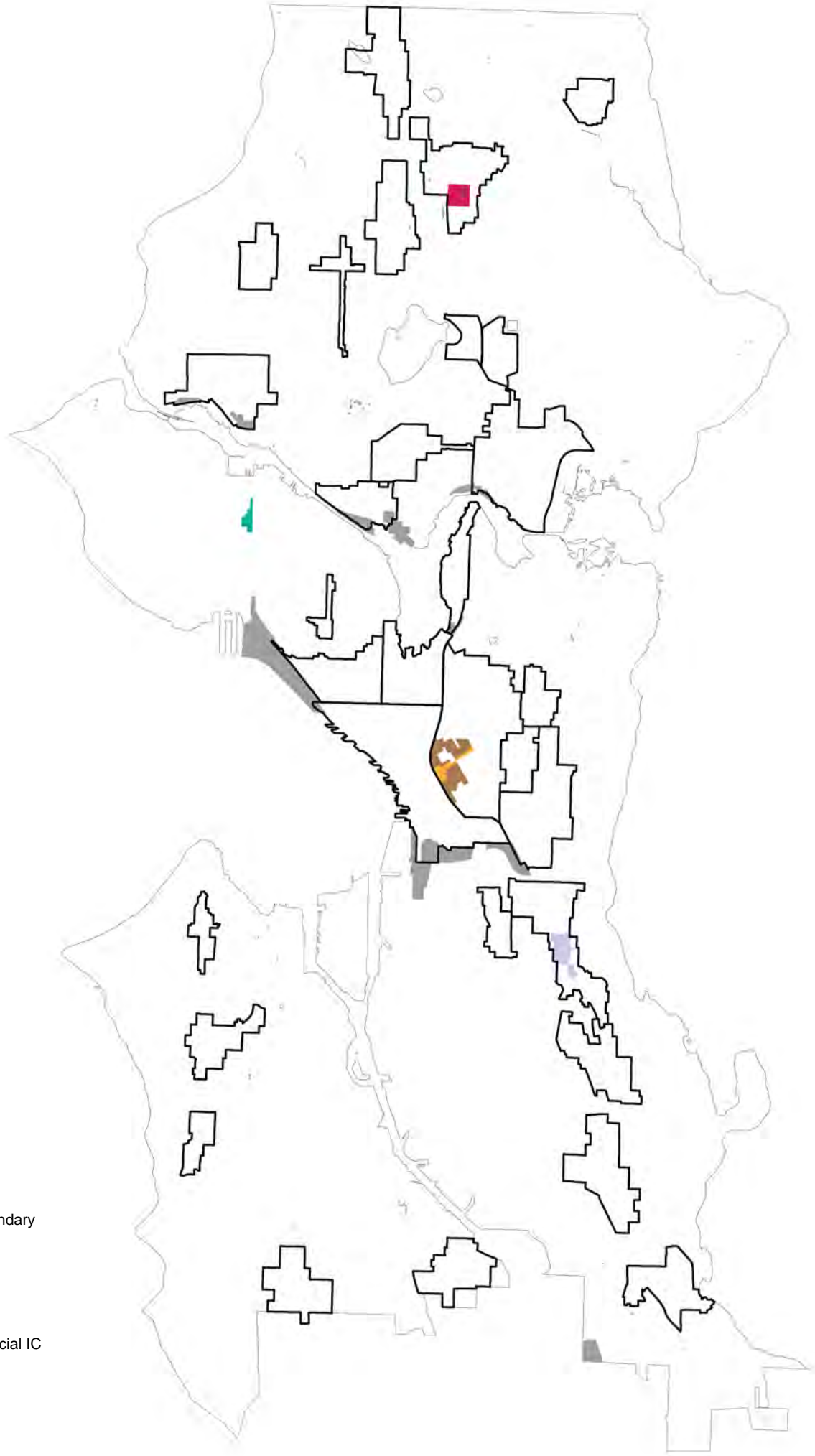

- Urban Village Boundary
- Existing NC-125
- Existing NC-160
- Existing HR
- Industrial Commercial IC
- SM-D
- SM-NR



HOUSING AFFORDABILITY
AND LIVABILITY AGENDA
